

DDS

SKU:U105

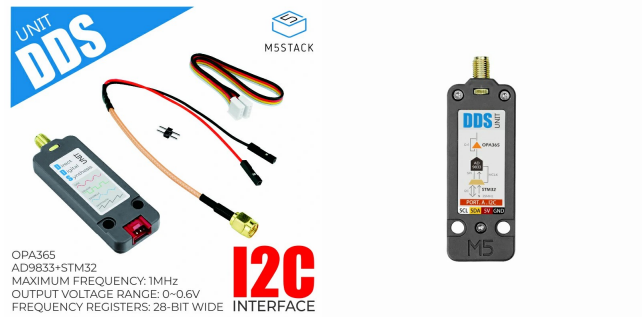

Description

DDS is a signal source Unit. It uses the AD9833 programmable waveform generator + STM32F0 micro controller. Based on I2C communication interface (addr:0x31) It can easily control the signal source to output multiple waveforms (sine wave, triangle wave, square wave output, sawtooth wave, signal output amplitude 0-0.6V) and adjust the frequency and phase.

It supports deep sleep mode, which can reduce the power consumption in the idle state. The Unit is suitable for the electronic circuit prototype design of various test instruments as a signal source.

Product Features

- Digital programmable frequency and phase
- Signal output amplitude 0-0.6V
- Sine wave/Triangle wave/Square wave/Sawtooth wave (fixed frequency: 13.6KHz)/DC output
- Output frequency range: 0MHz to 1MHz (10MHz based on the reference clock)
- 28bit frequency resolution
- 11bit phase resolution

Includes

- 1x DDS Unit
- 1x HY2.0-4P cable
- 1x SMA-2.54mm cable

Application

- Frequency stimulation/waveform generation
- Liquid flow and airflow measurement
- Sensor applications: proximity, motion and defect detection
- Line loss/attenuation
- Testing and medical equipment
- Scan/clock generator
- Time domain reflectometry (TDR) application

Specification

Specifications	Parameters
Support waveform	Sine wave/Triangle wave/Square wave/Sawtooth wave (fixed frequency: 13.6KHz)/DC output
Signal output amplitude	0-0.6V
Output frequency range	0MHz to 1MHz (10MHz based on the reference clock)
Frequency resolution	28bit
Phase resolution	11bit
Net weight	11.1g
Gross weight	34.7g
Product size	71*24*8mm
Package size	88.5*60*21mm

Related Links

- [AD9833](#)

EasyLoader

EasyLoader is a concise and fast program writer, which has a built-in case program related to the product. It can be burned to the main control by simple steps to perform a series of function verification. Please install the corresponding driver according to the device type. M5Core host [Please click here to view the CP210X driver installation tutorial](#)

2, Select COM



1, Downloads

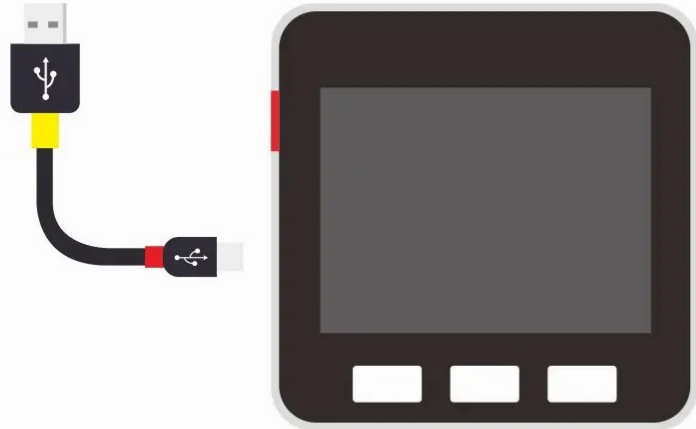

Core \ M5StickC \ M5StickV...

3, Burn Firmware

Windows

| Example

1. Arduino

- [Arduino example program](#)

| Schematic

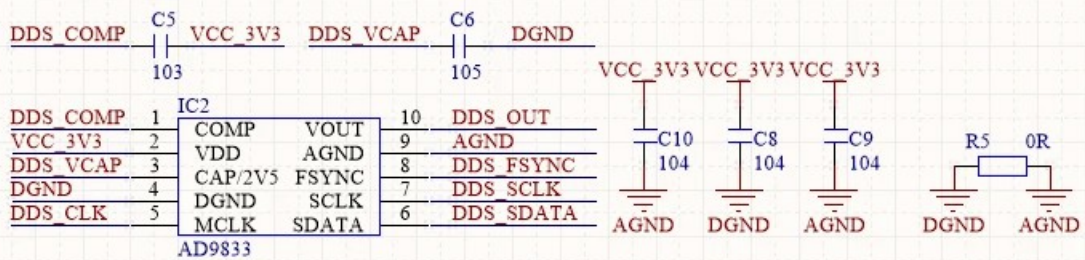
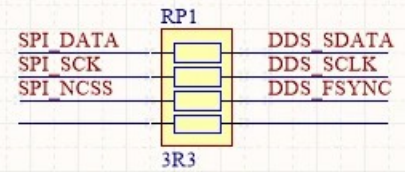
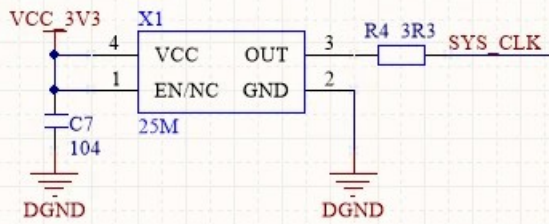
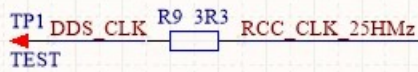
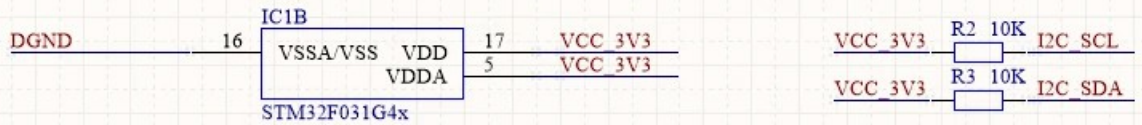
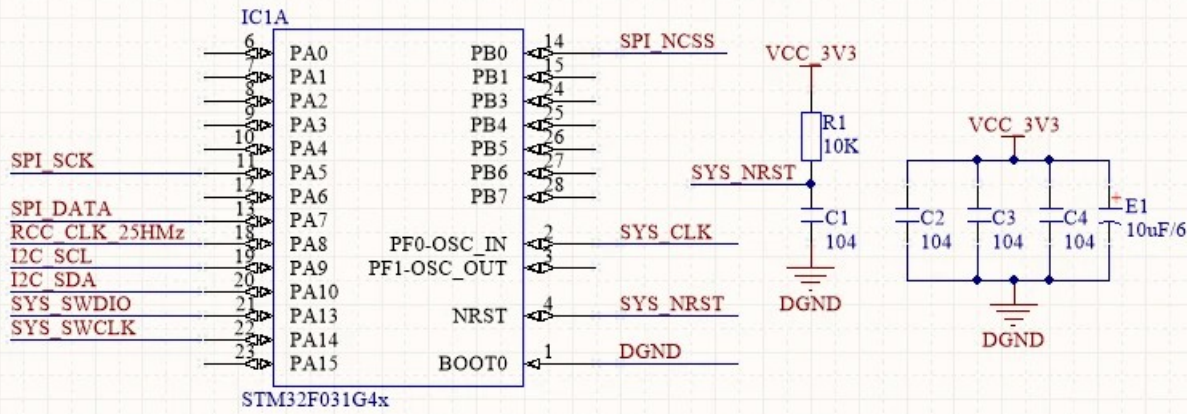

Pin mapping

M5Core	SCL	SDA	5V	GND
DDS Unit	GPIO22	GPIO21	5V	GND

Protocol

- Protocol type I2C
- I2C Address: 0x31

When writing a register, the highest bit must be set to 1. The mclk is set to "1" by default, it will keep the last output signal magnitude. Once the DAC is set to 1, it stops the Unit output.

/*-----*/

| DDS CTRL REG | 0x20

| dds_ctrl_reg[0] | R/W | System control

| 7 | 6 | 5 | 4 | 3 | 2 | 1 | 0 |

| W | R | R | R | R | MODE |

| -MODE: 000 Reserved

| 001 SINE

| 010 TRIANGLE

| 011 SQUARE

| 100 SAWTOOTH

| 101 DC

//

| dds_ctrl_reg[1] | R/W | System control

| 7 | 6 | 5 | 4 | 3 | 2 | 1 | 0 |

| W | FSELECT | PSELECT | S01 | S12 | RSET | R | R |

| -FSELECT: 0 Used FREQ0

1 Used FREQ1

| -PSELECT: 0 Used PHASE0

1 Used PHASE1

| -SLEEP01: 1 Disenable mclk

| -SLEEP12: 1 Disenable DAC

/*-----*/

/*-----*/

| DDS FREQ PHASE REG | 0x30

| dds_freq_phase_reg[0:3] | R/W | FREQ(28bit)

| 31 | 30 | 29:28 | 27:0 |

| W | N | R | freq reg 0 |

//

| dds_freq_phase_reg[4:5] | R/W | PHASE(12bit)

| 15 | 14 | 13:12 | 11:0 |

| W | N | R | phase reg 1 |

//

/*-----*/