



**MICROCHIP**

---

**RN131/171 Evaluation Kit  
User's Guide**

---

**Note the following details of the code protection feature on Microchip devices:**

- Microchip products meet the specification contained in their particular Microchip Data Sheet.
- Microchip believes that its family of products is one of the most secure families of its kind on the market today, when used in the intended manner and under normal conditions.
- There are dishonest and possibly illegal methods used to breach the code protection feature. All of these methods, to our knowledge, require using the Microchip products in a manner outside the operating specifications contained in Microchip's Data Sheets. Most likely, the person doing so is engaged in theft of intellectual property.
- Microchip is willing to work with the customer who is concerned about the integrity of their code.
- Neither Microchip nor any other semiconductor manufacturer can guarantee the security of their code. Code protection does not mean that we are guaranteeing the product as "unbreakable."

Code protection is constantly evolving. We at Microchip are committed to continuously improving the code protection features of our products. Attempts to break Microchip's code protection feature may be a violation of the Digital Millennium Copyright Act. If such acts allow unauthorized access to your software or other copyrighted work, you may have a right to sue for relief under that Act.

---

Information contained in this publication regarding device applications and the like is provided only for your convenience and may be superseded by updates. It is your responsibility to ensure that your application meets with your specifications. MICROCHIP MAKES NO REPRESENTATIONS OR WARRANTIES OF ANY KIND WHETHER EXPRESS OR IMPLIED, WRITTEN OR ORAL, STATUTORY OR OTHERWISE, RELATED TO THE INFORMATION, INCLUDING BUT NOT LIMITED TO ITS CONDITION, QUALITY, PERFORMANCE, MERCHANTABILITY OR FITNESS FOR PURPOSE. Microchip disclaims all liability arising from this information and its use. Use of Microchip devices in life support and/or safety applications is entirely at the buyer's risk, and the buyer agrees to defend, indemnify and hold harmless Microchip from any and all damages, claims, suits, or expenses resulting from such use. No licenses are conveyed, implicitly or otherwise, under any Microchip intellectual property rights.

**Trademarks**

The Microchip name and logo, the Microchip logo, dsPIC, FlashFlex, KEELOQ, KEELOQ logo, MPLAB, PIC, PICmicro, PICSTART, PIC<sup>32</sup> logo, rPIC, SST, SST Logo, SuperFlash and UNI/O are registered trademarks of Microchip Technology Incorporated in the U.S.A. and other countries.

FilterLab, Hampshire, HI-TECH C, Linear Active Thermistor, MTP, SEEVAL and The Embedded Control Solutions Company are registered trademarks of Microchip Technology Incorporated in the U.S.A.

Silicon Storage Technology is a registered trademark of Microchip Technology Inc. in other countries.

Analog-for-the-Digital Age, Application Maestro, BodyCom, chipKIT, chipKIT logo, CodeGuard, dsPICDEM, dsPICDEM.net, dsPICworks, dsSPEAK, ECAN, ECONOMONITOR, FanSense, HI-TIDE, In-Circuit Serial Programming, ICSP, Mindi, MiWi, MPASM, MPF, MPLAB Certified logo, MPLIB, MPLINK, mTouch, Omniscient Code Generation, PICC, PICC-18, PICDEM, PICDEM.net, PICkit, PICtail, REAL ICE, rLAB, Select Mode, SQI, Serial Quad I/O, Total Endurance, TSHARC, UniWinDriver, WiperLock, ZENA and Z-Scale are trademarks of Microchip Technology Incorporated in the U.S.A. and other countries.

SQTP is a service mark of Microchip Technology Incorporated in the U.S.A.

GestIC and ULPP are registered trademarks of Microchip Technology Germany II GmbH & Co. & KG, a subsidiary of Microchip Technology Inc., in other countries.

All other trademarks mentioned herein are property of their respective companies.

© 2013, Microchip Technology Incorporated, Printed in the U.S.A., All Rights Reserved.

 Printed on recycled paper.

ISBN: 978-1-62077-365-9

**QUALITY MANAGEMENT SYSTEM  
CERTIFIED BY DNV  
= ISO/TS 16949 =**

*Microchip received ISO/TS-16949:2009 certification for its worldwide headquarters, design and wafer fabrication facilities in Chandler and Tempe, Arizona; Gresham, Oregon and design centers in California and India. The Company's quality system processes and procedures are for its PIC<sup>®</sup> MCUs and dsPIC<sup>®</sup> DSCs, KEELOQ<sup>®</sup> code hopping devices, Serial EEPROMs, microperipherals, nonvolatile memory and analog products. In addition, Microchip's quality system for the design and manufacture of development systems is ISO 9001:2000 certified.*

**Object of Declaration: RN131/171 Evaluation Kit**

EU Declaration of Conformity

This declaration of conformity is issued by the manufacturer.

The development/evaluation tool is designed to be used for research and development in a laboratory environment. This development/evaluation tool is not a Finished Appliance, nor is it intended for incorporation into Finished Appliances that are made commercially available as single functional units to end users under EU EMC Directive 2004/108/EC and as supported by the European Commission's Guide for the EMC Directive 2004/108/EC (8<sup>th</sup> February 2010).

This development/evaluation tool complies with EU RoHS2 Directive 2011/65/EU.

For information regarding the exclusive, limited warranties applicable to Microchip products, please see Microchip's standard terms and conditions of sale, which are printed on our sales documentation and available at [www.microchip.com](http://www.microchip.com).

Signed for and on behalf of Microchip Technology Inc. at Chandler, Arizona, USA

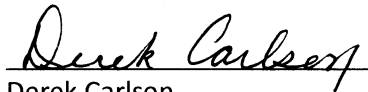

Derek Carlson  
VP Development Tools

16-July-2013

Date

**NOTES:**

---



---

## Table of Contents

---



---

<b>Preface .....</b>	<b>7</b>
<b>Chapter 1. Overview</b>	
1.1 Introduction .....	13
1.2 RN131/171 Evaluation Kit Features .....	13
1.3 RN131/171 Evaluation Kit Contents and Part Details .....	14
1.4 RN131 and RN171 Evaluation Kits Content .....	15
1.5 RN131/171 Evaluation Related Contents .....	18
<b>Chapter 2. Getting Started</b>	
2.1 Introduction .....	19
2.2 Hardware Requirements .....	19
2.3 Software/Utility Requirements .....	20
2.4 Module Configuration .....	21
<b>Chapter 3. Application Design Concerns</b>	
3.1 Introduction .....	29
<b>Appendix A. RN131 and RN171 Evaluation Kits Schematic</b>	
A.1 Introduction .....	31
A.2 RN131 and RN171 Evaluation Kits Schematic .....	31
A.3 RN131 and RN171 Evaluation Kits PCB Layout and Assembly Drawings ..	34
A.4 RN131 and RN171 Evaluation Kits Bill of Materials .....	40
A.5 RN131 and RN171 Evaluation Kits Physical Dimensions .....	42
<b>Index .....</b>	<b>45</b>
<b>Worldwide Sales and Service .....</b>	<b>46</b>

# RN131/171 Evaluation Kit User's Guide

---

---

NOTES:

---

---

## Preface

---

---

### NOTICE TO CUSTOMERS

All documentation becomes dated, and this manual is no exception. Microchip tools and documentation are constantly evolving to meet customer needs, so some actual dialogs and/or tool descriptions may differ from those in this document. Please refer to our web site ([www.microchip.com](http://www.microchip.com)) to obtain the latest documentation available.

Documents are identified with a “DS” number. This number is located on the bottom of each page, in front of the page number. The numbering convention for the DS number is “DSXXXXA”, where “XXXX” is the document number and “A” is the revision level of the document.

For the most up-to-date information on development tools, see the MPLAB® IDE online help. Select the Help menu, and then Topics to open a list of available online help files.

### INTRODUCTION

This chapter contains general information that will be useful to know before using the RN131/171 Evaluation Board User's Guide. Items discussed in this chapter include:

- [Document Layout](#)
- [Conventions Used in this Guide](#)
- [Warranty Registration](#)
- [Recommended Reading](#)
- [The Microchip Web Site](#)
- [Development Systems Customer Change Notification Service](#)
- [Customer Support](#)
- [Document Revision History](#)

### DOCUMENT LAYOUT

This document describes how to use the RN131/171 Evaluation Board. The manual layout is as follows:

- **Chapter 1. “Overview”** – This chapter describes the RN131 and RN171 Evaluation Kits that are used for demonstrating the RN131 and RN171 module capabilities. These boards have the flexibility to connect directly to computers/laptops through a standard USB interface or to an embedded controllers through the serial UART interface.
- **Chapter 2. “Getting Started”** – This chapter describes the RN131 and RN171 Evaluation Kits as an independent development board to add Wi-Fi® connectivity to embedded systems. Certain hardware and software/utilities are essential to support the development of demo applications which are also discussed in this chapter.

# RN131/171 Evaluation Kit User's Guide

- **Chapter 3. “Application Design Concerns”** – This chapter provides design concerns related to powering the evaluation board, sensor interface settings, Ad hoc mode, and restoring factory settings.
- **Appendix A. “RN131 and RN171 Evaluation Kits Schematic”** – This appendix provides the RN131 and RN171 Evaluation Boards schematic, PCB layout and Bill of Materials (BOM).

## CONVENTIONS USED IN THIS GUIDE

This manual uses the following documentation conventions:

### DOCUMENTATION CONVENTIONS

Description	Represents	Examples
<b>Arial font:</b>		
Italic characters	Referenced books	<i>MPLAB® IDE User's Guide</i>
	Emphasized text	...is the <i>only</i> compiler...
Initial caps	A window	the Output window
	A dialog	the Settings dialog
	A menu selection	select Enable Programmer
Quotes	A field name in a window or dialog	"Save project before build"
Underlined, italic text with right angle bracket	A menu path	<i><u>File</u>&gt;Save</i>
Bold characters	A dialog button	Click <b>OK</b>
	A tab	Click the <b>Power</b> tab
Text in angle brackets < >	A key on the keyboard	Press <Enter>, <F1>
<b>Courier New font:</b>		
Plain Courier New	Sample source code	#define START
	Filenames	autoexec.bat
	File paths	c:\mcc18\h
	Keywords	_asm, _endasm, static
	Command-line options	-Opa+, -Opa-
	Bit values	0, 1
	Constants	0xFF, 'A'
Italic Courier New	A variable argument	<i>file.o</i> , where <i>file</i> can be any valid filename
Square brackets [ ]	Optional arguments	mcc18 [options] <i>file</i> [options]
Curly brackets and pipe character: {   }	Choice of mutually exclusive arguments; an OR selection	errorlevel {0 1}
Ellipses...	Replaces repeated text	var_name [, var_name...]
	Represents code supplied by user	void main (void) { ... }



## WARRANTY REGISTRATION

Please complete the enclosed Warranty Registration Card and mail it promptly. Sending in the Warranty Registration Card entitles you to receive new product updates. Interim software releases are available at the Microchip web site.

## RECOMMENDED READING

This user's guide describes how to use the RN-131-EK and RN-171-EK Evaluation Boards. Other useful documents are listed below. The following Microchip documents are available and recommended as supplemental reference resources.

RN131 Module Data Sheet (DS75085)

RN171 Module Data Sheet (DS75084)

PICDEM™ PIC18 Explorer Demonstration Board User's Guide (DS51721)

Explorer 16 Development Board User's Guide (DS51589)

WiFly Command Reference, Advanced Features and Applications User's Guide

## THE MICROCHIP WEB SITE

Microchip provides online support through our web site at <http://www.microchip.com>. This web site is used as a means to make files and information easily available to customers. Accessible by using your favorite Internet browser, the web site contains the following information:

- **Product Support** – Data sheets and errata, application notes and sample programs, design resources, user's guides and hardware support documents, latest software releases and archived software
- **General Technical Support** – Frequently Asked Questions (FAQs), technical support requests, online discussion groups, Microchip consultant program member listing
- **Business of Microchip** – Product selector and ordering guides, latest Microchip press releases, listing of seminars and events, listings of Microchip sales offices, distributors and factory representatives

## DEVELOPMENT SYSTEMS CUSTOMER CHANGE NOTIFICATION SERVICE

Microchip's customer notification service helps keep customers current on Microchip products. Subscribers will receive e-mail notification whenever there are changes, updates, revisions or errata related to a specified product family or development tool of interest.

To register, access the Microchip web site at <http://www.microchip.com>, click **Customer Change Notification** and follow the registration instructions.

The Development Systems product group categories are:

- **Compilers** – The latest information on Microchip C compilers and other language tools. These include the MPLAB<sup>®</sup> C compiler; MPASM<sup>™</sup> and MPLAB 16-bit assemblers; MPLINK<sup>™</sup> and MPLAB 16-bit object linkers; and MPLIB<sup>™</sup> and MPLAB 16-bit object librarians.
- **Emulators** – The latest information on the Microchip MPLAB REAL ICE<sup>™</sup> in-circuit emulator.
- **In-Circuit Debuggers** – The latest information on the Microchip in-circuit debugger, MPLAB ICD 3.
- **MPLAB<sup>®</sup> IDE** – The latest information on Microchip MPLAB IDE, the Windows<sup>®</sup> Integrated Development Environment for development systems tools. This list is focused on the MPLAB IDE, MPLAB SIM simulator, MPLAB IDE Project Manager and general editing and debugging features.
- **Programmiers** – The latest information on Microchip programmers. These include the MPLAB PM3 device programmers and the PICkit<sup>™</sup> 3 development programmers.

## CUSTOMER SUPPORT

Users of Microchip products can receive assistance through several channels:

- Distributor or Representative
- Local Sales Office
- Field Application Engineer (FAE)
- Technical Support

Customers should contact their distributor, representative or FAE for support. Local sales offices are also available to help customers. A listing of sales offices and locations is included in the back of this document.

Technical support is available through our web site at: <http://support.microchip.com>

## DOCUMENT REVISION HISTORY

### **Revision A (August 2013)**

This is the initial released version of the document.

NOTES:

---

---

## Chapter 1. Overview

---

---

### 1.1 INTRODUCTION

This chapter describes the RN131/171 Evaluation Kits that are used for demonstrating the RN131 and RN171 module capabilities. These boards have the flexibility to connect directly to computers/laptops through a standard USB interface or to embedded controllers through the serial UART interface. These evaluation boards contain two push buttons, namely RESET and FN. The RESET button is used to reset the module and the FN button is used to launch different applications depending on software configuration. The status LEDs enables quick debug support.

The RN171 Evaluation Board has an additional flexibility of powering up through battery pack (two AAA batteries) apart from connecting through USB cable to the host PC. Analog sensor interface supported by RN131 and RN171 Evaluation Boards also provides direct connections to read analog signals such as temperature, acceleration and so on.

For data sheet and other details related to RN131 and RN171 modules refer to the Microchip web site <http://www.microchip.com>.

This chapter discusses the following topics:

- [RN131/171 Evaluation Kit Features](#)
- [RN131/171 Evaluation Kit Contents and Part Details](#)
- [RN131 and RN171 Evaluation Kits Content](#)
- [RN131/171 Evaluation Related Contents](#)

### 1.2 RN131/171 EVALUATION KIT FEATURES

#### 1.2.1 RN131 Evaluation Board Features

The RN131 Evaluation Board has the following features:

- Supports FCC/CE/IC certified 2.4 GHz IEEE 802.11 b/g RN131 module
- Wi-Fi® Alliance certified for WPA2-PSK and RoHS compliant
- Complete on-board TCP/IP networking stack through RN131 module
- Supports Ad hoc and Infrastructure networking modes along with SoftAP mode
- Built-in networking applications through RN131 module, such as, TCP/IP, DHCP, DNS, ARP, ICMP, UDP, Telnet, FTP client and HTML client
- Configuration over Wi-Fi or UART using simple ASCII commands
- Supports 921 Kbps TX, 500 Kbps RX data rates with TCP/IP and WPA2 over UART
- Powered by a USB cable (5V)
- Push buttons for launching Applications and RESET signals
- Real-time clock for wake up and time stamping
- The RN131 module includes an on-board ceramic chip antenna and a U.FL. connector
- Size – 50.8 mm x 28 mm x 5 mm
- Weight – approx. 10g

## 1.2.2 RN171 Evaluation Board Features

The RN171 Evaluation Board has the following features:

- Supports FCC/CE/IC certified 2.4 GHz IEEE 802.11 b/g RN171 module
- Wi-Fi Alliance certified for WPA2-PSK and RoHS compliant
- Complete on-board TCP/IP networking stack through RN171 module
- Supports Ad hoc and Infrastructure networking modes along with SoftAP mode
- Built-in networking applications through RN171 module, such as, TCP/IP, DHCP, DNS, ARP, ICMP, UDP, Telnet, FTP client and HTML client
- Configuration over Wi-Fi or UART using simple ASCII commands
- Supports 921 Kbps TX, 500 Kbps RX data rates with TCP/IP and WPA2 over UART
- Powered by 3.3V battery pack (two AAA batteries) or through a USB cable (5V)
- Push buttons for launching Applications and RESET signal
- 10 general purpose digital I/O pins
- Eight analog sensor interfaces; configurable sensor power outputs 0 – 3.3V DC
- Real-time clock for wake-up and time stamping
- Trace antenna included on the RN171 module
- Size – 50.8 mm x 28 mm x 20 mm
- Weight – approx. 13.5g

## 1.3 RN131/171 EVALUATION KIT CONTENTS AND PART DETAILS

Depending on the development kit ordered, the package contents contain one of the following development boards:

- RN-131-EK or EN-171-EK Board
- USB cable

[Table 1-1](#) lists the part number of RN-131/171-EK Evaluation Kit.

**TABLE 1-1: RN-131/171-EK EVALUATION KIT**

Description	Part Number
RN131 Evaluation Kit	RN-131-EK
RN171 Evaluation Kit	RN-171-EK

[Figure 1-1](#) illustrates the evaluation kit contents of RN-131-EK and RN-171-EK, respectively.

**FIGURE 1-1: EVALUATION KIT CONTENTS**

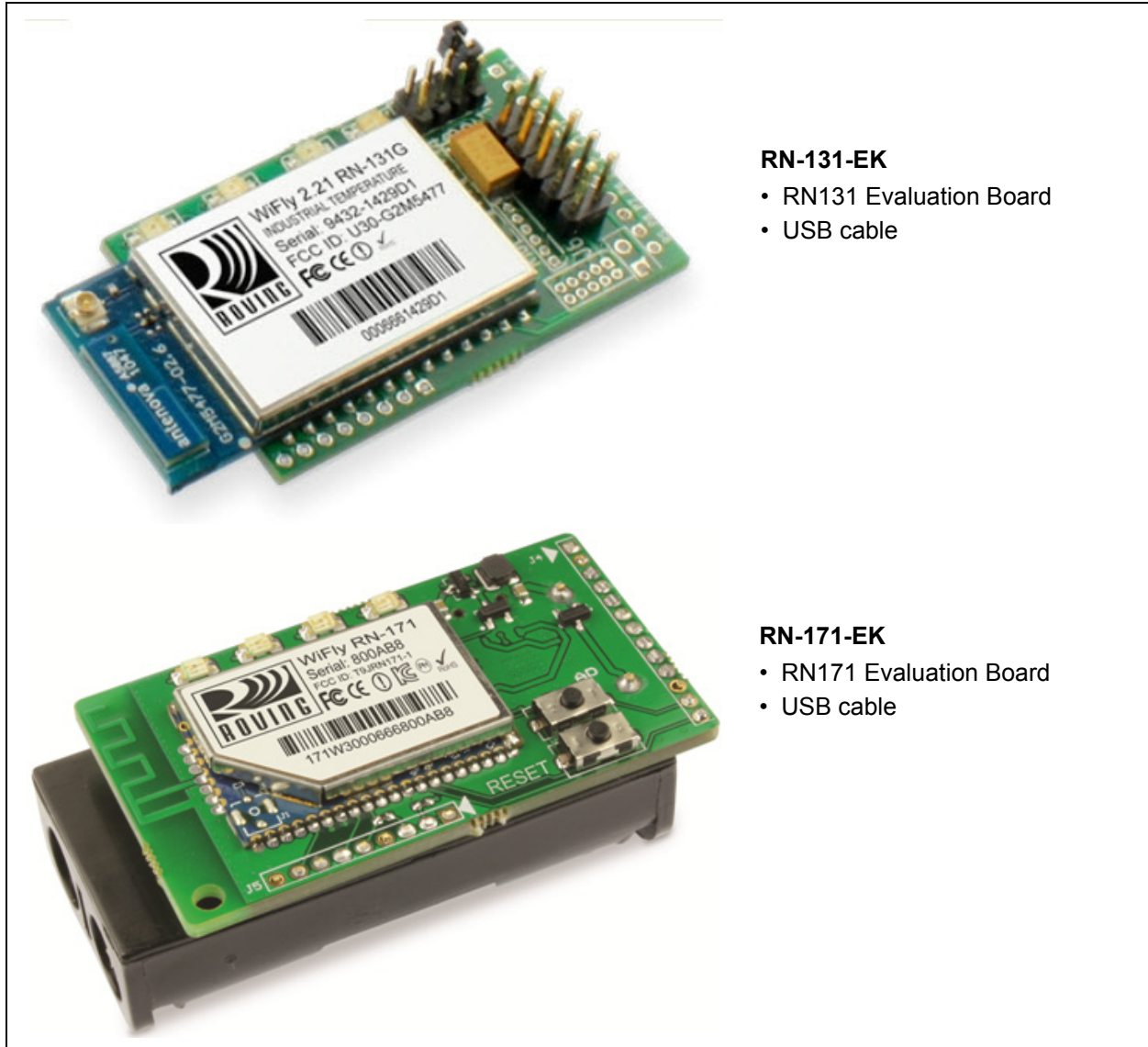

**RN-131-EK**

- RN131 Evaluation Board
- USB cable

**RN-171-EK**

- RN171 Evaluation Board
- USB cable

## 1.4 RN131 AND RN171 EVALUATION KITS CONTENT

[Figure 1-2](#) and [Figure 1-3](#) illustrate the components of RN131 and RN171 Evaluation Boards, respectively.

[Table 1-2](#) and [Table 1-3](#) depict the RN131 and RN171 Evaluation Board LED indicators.

# RN131/171 Evaluation Kit User's Guide

FIGURE 1-2: RN131 EVALUATION BOARD COMPONENTS

The diagram shows the RN131 Evaluation Board with various components labeled. The board features a central WiFly RN-131C module with a serial number of 304973 and FCC ID U30-G2M5477. It includes a USB connector, four LED indicators, a UART interface (J3), a sensor interface (J1), and two pushbuttons (Reset and AP/WPS/Factory Reset).

**UART Interface (J3)**

RX - input to evaluation board  
TX - output from evaluation board

Pin	Description
1	3.3 VDC output
2	GND
3	UART RX
4	UART TX
5	UART RTS
6	UART CTS
7	GPIO4
8	GPIO5
9	GPIO6
10	GPIO7
11	GPIO8
12	GPIO9
13	Reset

**Sensors (J1)**

Pin	Description
1	Sensor Power
2	Sensor 4 (3.3-V tolerant)
3	Sensor 5 (3.3-V tolerant)
4	Sensor 7 (1.2 V only)
5	Sensor 5 (1.2 V only)
6	Sensor 4 (1.2 V only)
7	Sensor 6 (1.2 V only)
8	Sensor 3 (1.2 V only)
9	GND

**WARNING:** Sensors must not have more than 1.2-V DC. Otherwise, the module may be permanently damaged.

TABLE 1-2: RN131 EVALUATION BOARD LED INDICATORS

Condition	Blue LED	Red LED	Yellow LED	Green LED
On Solid	Not Used	—	—	Connected over TCP
Fast Blink	Not Used	Not Associated	RX/TX Data Transfer	No IP address
Slow Blink	Not Used	Associated, no internet	—	IP address OK
Off	Not Used	Associated, internet OK	—	—



**FIGURE 1-3: RN171 EVALUATION BOARD COMPONENTS**

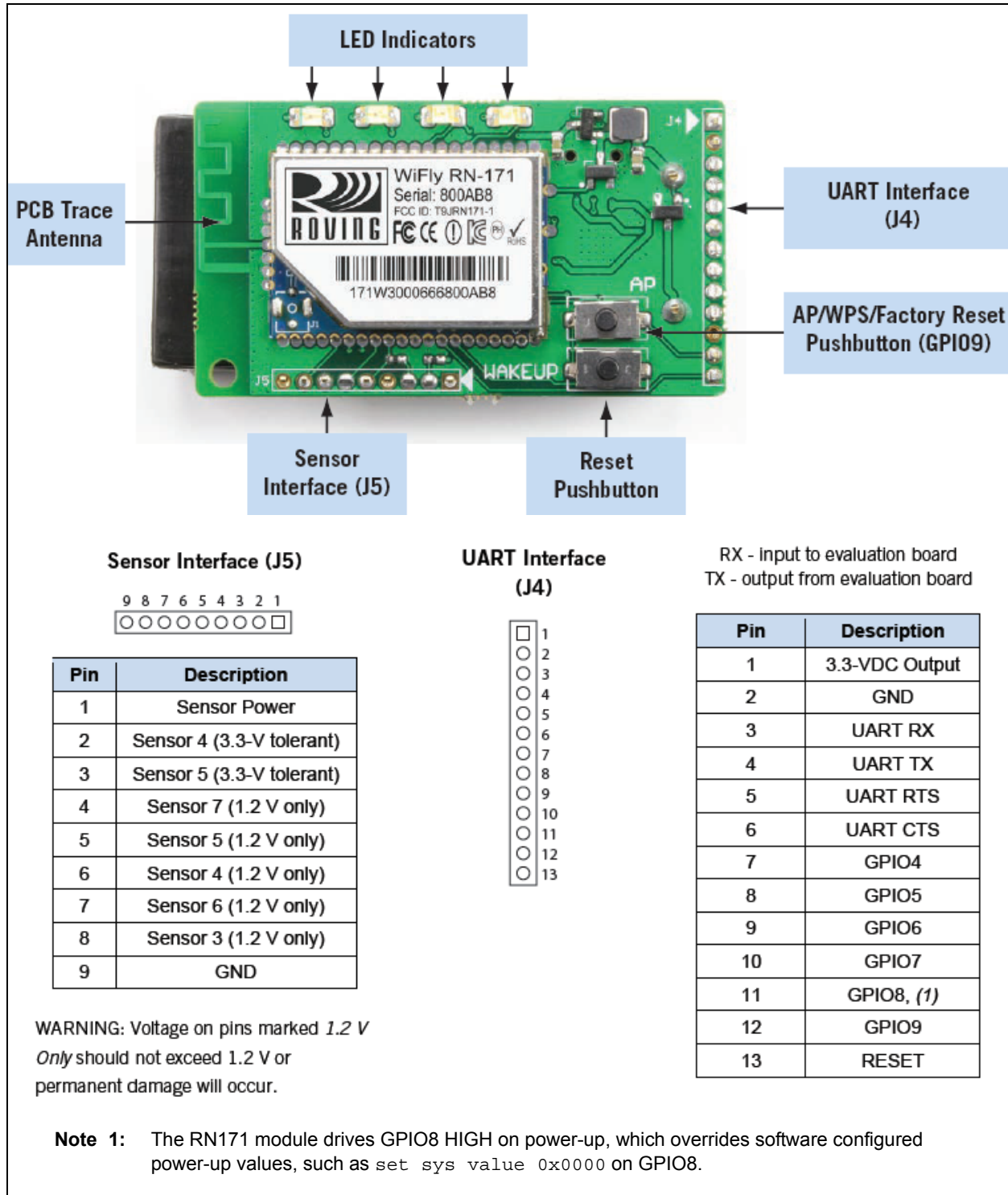

**TABLE 1-3: RN171 EVALUATION BOARD LED INDICATORS**

Condition	Blue LED	Red LED	Yellow LED	Green LED
On Solid	Not Used	—	—	Connected over TCP
Fast Blink	Not Used	Not Associated	RX/TX Data Transfer	No IP address
Slow Blink	Not Used	Associated, no internet	—	IP address OK
Off	Not Used	Associated, internet OK	—	—

# RN131/171 Evaluation Kit User's Guide

---

Table 1-4 provides an overview of the RN131/171 Evaluation Kit Hardware.

**TABLE 1-4: RN131/171 EVALUATION KIT HARDWARE**

Hardware	Description	RN-131-EK	RN-171-EK
Evaluation Board	Contains the WiFly module and connectors.	For RN131 Module	For RN171 Module
Power Up	Interface for powering up the evaluation boards.	USB	USB/Battery Pack
LEDs	To indicate status and for debugging.	Available	Available
Push Buttons	For launching applications.	Available	Available
Sensor Interface	On board ADC provides direct connections to read analog signals such as temperature, acceleration and so on.	Available	Available
Communication Interface	UART	Available	Available
USB Connector On-board	Provides power to the evaluation board and supports communication (COM Port).	Available	Available
SMA Connectors	U.FL and reverse SMA connectors.	Available	Not Available

## 1.5 RN131/171 EVALUATION RELATED CONTENTS

Example codes and other related information can be downloaded from the Microchip web site <http://www.microchip.com/RN-131-EK> or <http://www.microchip.com/RN-171-EK>.

**Note:** RN131/171 module firmware can be upgraded to the latest version through FTP update. For additional information on FTP update and commands, refer to “*WiFly Command Reference, Advanced Features and Applications User's Guide*” from the Microchip web site <http://www.microchip.com>.

---

---

## Chapter 2. Getting Started

---

---

### 2.1 INTRODUCTION

This chapter describes the RN131/171 Evaluation Kit board as an independent development board for exploring the ASCII command set and prototyping of embedded systems. Certain hardware and software/utilities are essential to support the development of demo applications.

This chapter discusses the following topics:

- [Hardware Requirements](#)
- [Software/Utility Requirements](#)
- [Module Configuration](#)

### 2.2 HARDWARE REQUIREMENTS

Along with an USB cable either RN-131-EK or RN-171-EK boards are required for evaluation hardware setup and to run the demo applications.

#### 2.2.1 Hardware Setup

The following are the steps to setup the RN131/171 Evaluation Board demo:

1. Supply power to RN-131-EK and RN-171-EK evaluation board using an USB cable. Alternatively, power can be supplied to RN-171-EK evaluation board by inserting two AAA batteries into the battery pack.
2. Connect the USB cable to a USB port on the host system and to the USB connector on the evaluation board.
3. If the drivers are not automatically installed, download and install the FTDI drivers from the Microchip web site "<http://ww1.microchip.com/downloads/en/Device-Doc/FTDI-Drivers.zip>" FTDI Chipset Drivers.
4. Once the FTDI drivers are installed, the COM port is automatically assigned based on the active connection.

[Figure 2-1](#) and [Figure 2-2](#) show the setup arrangement of RN131 and RN171 Evaluation Boards connected to computer/laptop.

FIGURE 2-1: RN131 EVALUATION BOARD HARDWARE SETUP



FIGURE 2-2: RN171 EVALUATION BOARD HARDWARE SETUP



## 2.3 SOFTWARE/UTILITY REQUIREMENTS

The following software tools/utilities are required to run the demo applications:

- Terminal Emulator Application such as TeraTerm (for Windows OS) or CoolTerm (for MAC OS)

**Note:** Terminal Emulator program is used to send the configuration commands to the module over a UART interface. The emulator also displays information transmitted from the module.

- Both RN131 and RN171 Evaluation Boards use the FTDI chip set. Windows automatically installs the drivers for the USB-serial cable. If the drivers are not automatically installed, download and install the FTDI drivers from the Microchip web site "<http://ww1.microchip.com/downloads/en/DeviceDoc/FTDI-Drivers.zip>" FTDI Chipset Drivers.

- Once the FTDI drivers are installed, the COM port is automatically assigned based on the active connection.

## 2.4 MODULE CONFIGURATION

The RN131/171 module operates in two modes:

- Data mode (default)
- Command mode

### 2.4.1 Data Mode

In Data mode, the RN131/171 module is essentially a data pipe. When the module receives data over Wi-Fi, it strips the TCP/IP headers and trailers, and passes the user data to the UART. When data is written to the UART, the module constructs the TCP/IP packet and sends it out over Wi-Fi. Thus, the entire process of sending/receiving data to the host is transparent to the end application/user microcontroller.

**FIGURE 2-3: APPLICATION INTERFACE FOR DATA AND COMMAND MODES**

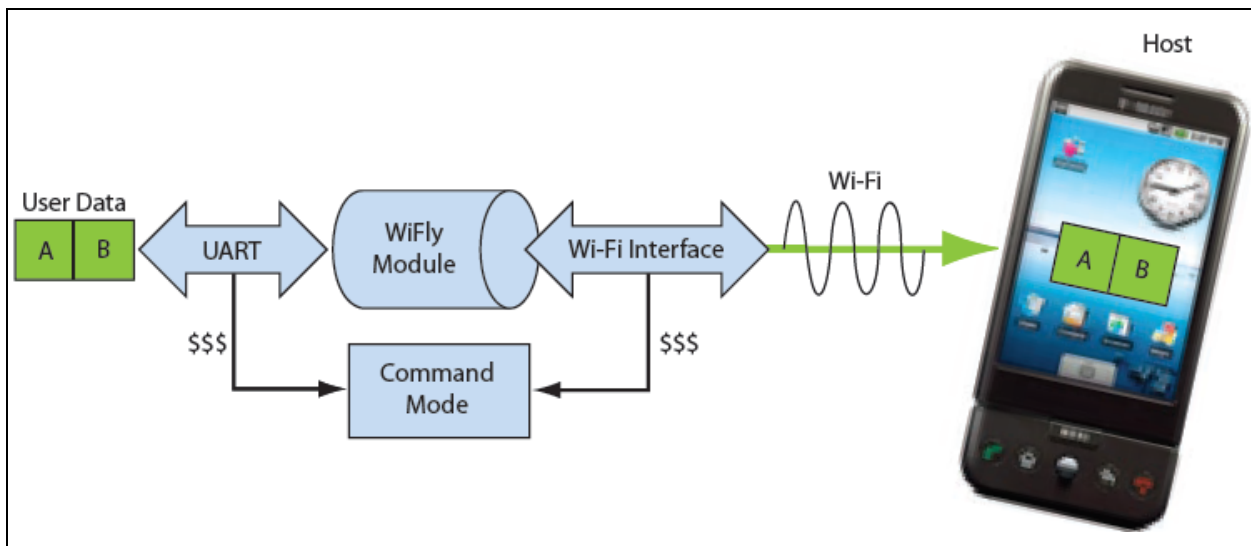

### 2.4.2 Command Mode

By default, the RN131/171 module is in Data mode. Sending an escape sequence \$\$\$ causes the module to enter the Command mode. Once in Command mode, module can be configured using simple ASCII commands. To exit Command mode and return to the Data mode, type `exit <cr>`. Figure 2-3 shows an application interface for Data and Command modes.

Basic configuration requires the wireless network access point's name (SSID) and the authentication password. The RN131/171 module can associate with only one network at a time. It is recommended to begin evaluation by configuring the RN131/171 module using an open access point to simplify the setup.

The following two methods are used to configure the RN131/171 module:

1. Over the UART, that is, connected to a computer/laptop or to a microcontroller
2. Through Wi-Fi using Ad hoc networking

Terminal emulator is required to type the commands and to monitor the transactions.

## 2.4.3 Configuration Using a USB Cable

The evaluation board uses a USB cable to allow the host computer to communicate with the RN131/171 module on the evaluation board.

The following instructions describe how to use a terminal emulator to go into Configuration mode, send commands to find networks, associate with an access point and save configuration.

### 2.4.3.1 CONFIGURE THE MODULE USING A TERMINAL EMULATOR

Either the TeraTerm (for Windows OS) or CoolTerm (for Mac OS-X), terminal emulator program can be used. Also legacy evaluation boards uses a USB-to-serial cable for connecting the evaluation board with the computer/laptop. When using either of the RN131/171 evaluation board, use the COM port to which the USB-to-serial cable is connected.

The following are the steps to communicate with the module using a terminal emulator:

1. Determine the COM port that is assigned to the USB cable (the port is COM9 in the example shown in [Figure 2-4](#)).
2. Open the available terminal emulation program and specify the COM port.
3. When using TeraTerm, go to Serial option and select the COM port number from the drop-down menu.
4. The serial port with the required settings are as follows:
  - Baud: 9600
  - Data bits: 8
  - Parity: None
  - Stop bits: 1
  - Flow control: None
5. Type the commands through the terminal emulator program and to the assigned program.

**Note:** COM port number can be found as follows:

- For Windows OS: Go to the Windows Device Manager, from System Tools. In the Device Manager, browse and expand the selection for serial ports (COM & LPT). Use TeraTerm for other configuration settings and monitoring.
- For MAC OS: When using CoolTerm, view and select the port from the same terminal emulator application.

**FIGURE 2-4: FINDING THE COM PORT NUMBER IN WINDOWS**

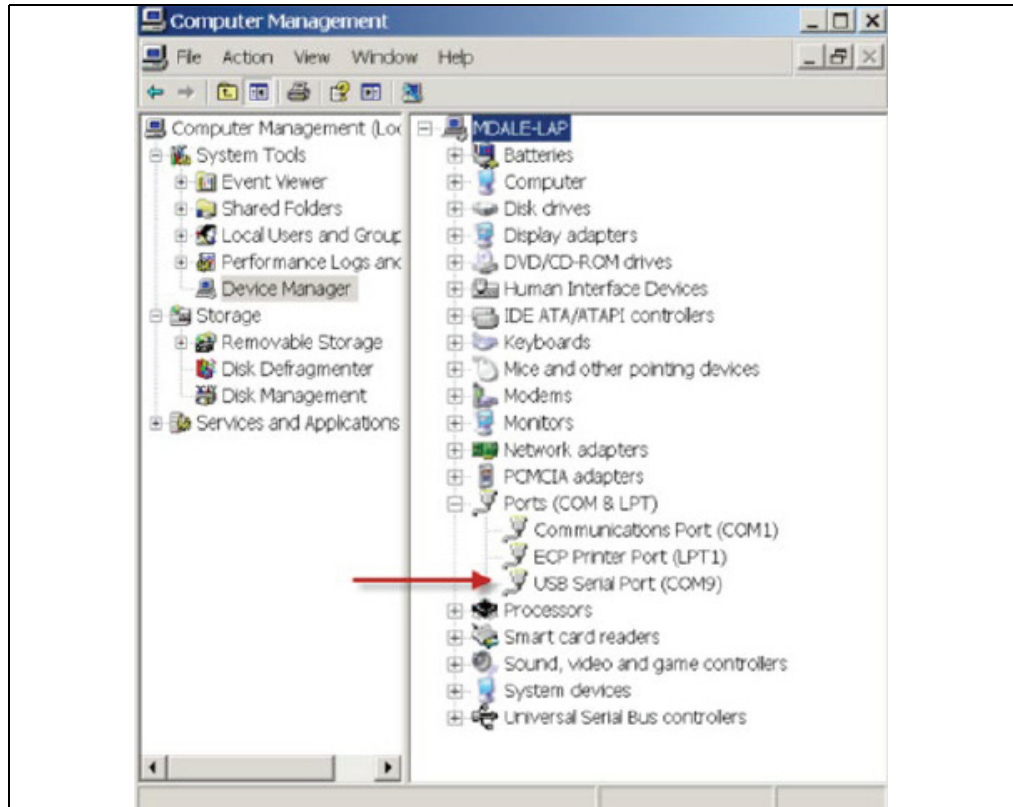

### 2.4.3.2 ENTER COMMAND MODE

The following are the steps to enter the Command mode in a terminal emulator:

1. Type \$\$\$ on the keyboard sequentially with no additional characters before or after each \$ sign. The module replies with CMD (on terminal emulator) to indicate it is in Command mode.
2. Type show net <cr> to display the current network settings (Figure 2-5 shows the current network settings for the version 2.28).

**Note:** When a command is completed, the terminal displays a prompt in the format <X.XX>, where X.XX indicates the module's firmware version.

**FIGURE 2-5: CURRENT NETWORK SETTINGS**

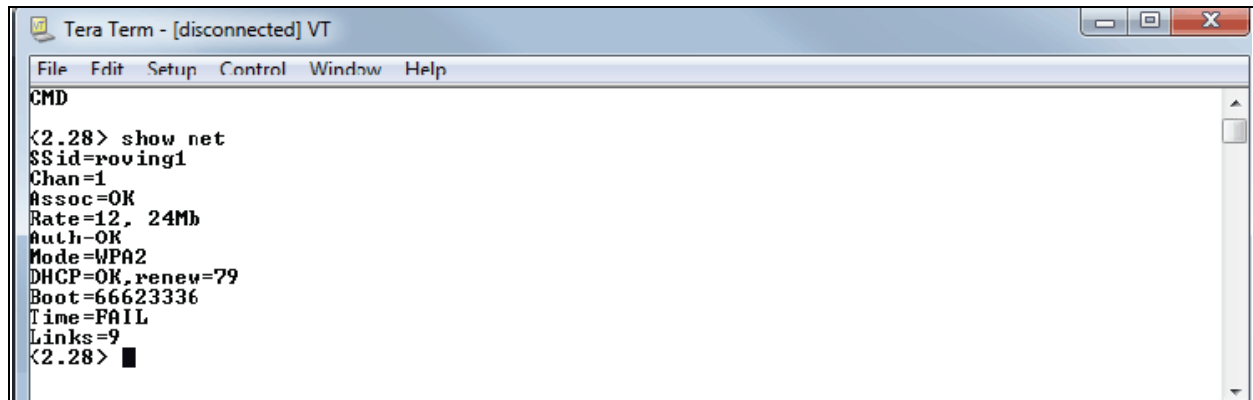



Commands to the module is first sent with a keyword followed by an optional parameter. Spaces are not allowed to use as parameters. The commands are case sensitive. Use a \$ to indicate a space (For example, MY NETWORK must be written as MY\$NETWORK). Additionally, short form for the parameters can be used. For example, the following commands are equivalent:

```
set uart baudrate 115200
set uart b 115200
set u b 15200
```

**Note:** Short forms are not used for command keywords. For example, `s uart baudrate 115200` is illegal.

The RN131/171 module supports a variety of command keywords. The WiFly Command Reference, Advanced Features and Applications User's Guide Reference from the Microchip web site <http://www.microchip.com> provides a complete command of references.

For evaluation purposes, view the current settings using the `get` command; `get everything` shows all parameters. Table 2-1 shows an additional parameters that can be used with `set` and `get` commands.

**TABLE 2-1: BASIC SET AND GET PARAMETERS**

Parameter	Function
adhoc	Controls the Ad hoc parameters
broadcast	Controls the broadcast hello/heartbeat UDP message
comm	Communication and data transfer, matching characters
dns	DNS host and domain
ftp	FTP host address and login information
ip	IP settings
option	Optional and infrequently used parameters
sys	System settings (e.g., sleep and wake timers)
time	Real-time clock settings
uart	Serial port settings (e.g., baud rate and parity)
wlan	Wireless interface (e.g., SSID, channel and security options)

### 2.4.3.3 FIND AVAILABLE NETWORKS

In Command mode, instruct the RN131/171 module to search for the available networks. By typing `scan <cr>` in the terminal emulator a list of Wi-Fi networks within the radio range can be viewed. Figure 2-6 shows the scanned network/access points.



FIGURE 2-6: AVAILABLE NETWORKS THROUGH SCAN COMMAND

```

COM3 - Tera Term VT
File Edit Setup Control Window Help
scan
<2.23>
SCAN:Found 8
Num      SSID      Ch  RSSI   Sec   MAC Address      Suites
1        SensorNet 01  -46   WPA2PSK 00:22:3f:6b:95:42 AESM-AES 1104 2
2        roving1   01  -53   WPA2PSK 00:15:6d:fa:53:86 AESM-AES 3100 3
3        bertcontrol 06  -75   Open    00:18:02:70:7e:e8 2100 0
4        roving-guest 06  -78   WPA2PSK 00:26:f2:4f:89:d6 AESM-AES 3104 0
5        miniblack 06  -72   WPA2PSK 00:23:15:55:46:7d AESM-AES 3100 0
6        portthru 10  -58   Open    6a:2d:4d:22:96:ee Adhoc 200 0
7        CoolBox  11  -60   WPA2PSK 00:16:b6:45:63:98 AESM-AES 3104 0
8        linksys_WPS_4016 11  -69   WPA_Mix 00:1e:e5:67:73:b1 AES/TRIPM-TRIP 1104 0
join roving1
DeAuth
Auto-Assoc roving1 chan=1 mode=WPA2 SCAN OK
Joining roving1 now..
<2.23> Associated!
DHCP: Start
DHCP in 37ms, lease=120s
IF=UP
DHCP=ON
IP=192.168.2.66:2000
NM=255.255.255.0
GW=192.168.2.1

```

#### 2.4.3.4 ASSOCIATE WITH AN ACCESS POINT

Use the `join` keyword to associate with an open access point. Figure 2-6 shows `roving1` as an open access point in the scan list.

To associate with an access point, type the following commands:

```

join roving1
or
join # 1

```

To disconnect from a network, type `leave <cr>`. The Red LED blinks quickly when the RN131/171 module is not associated with an access point.

To associate a module automatically with a network upon booting (i.e., persistent configuration), use the `set wlan` command with the SSID. For example, type the following commands:

```

set wlan ssid roving1
save
reboot

```

When the module wakes or power cycles, the module attempts to associate with the network `roving1`. To associate with a secure network, the module requires the network password. The WiFly RN131/171 module determines the security type automatically. In this case, type the following commands:

```

set wlan ssid roving1
set wlan pass rubygirl
set wlan join 1 //enables auto join
save
reboot

```

Figure 2-7 shows the secured network connection. To confirm this established connection and security settings type `get wlan <cr>`.

FIGURE 2-7: CONNECT TO A SECURE NETWORK

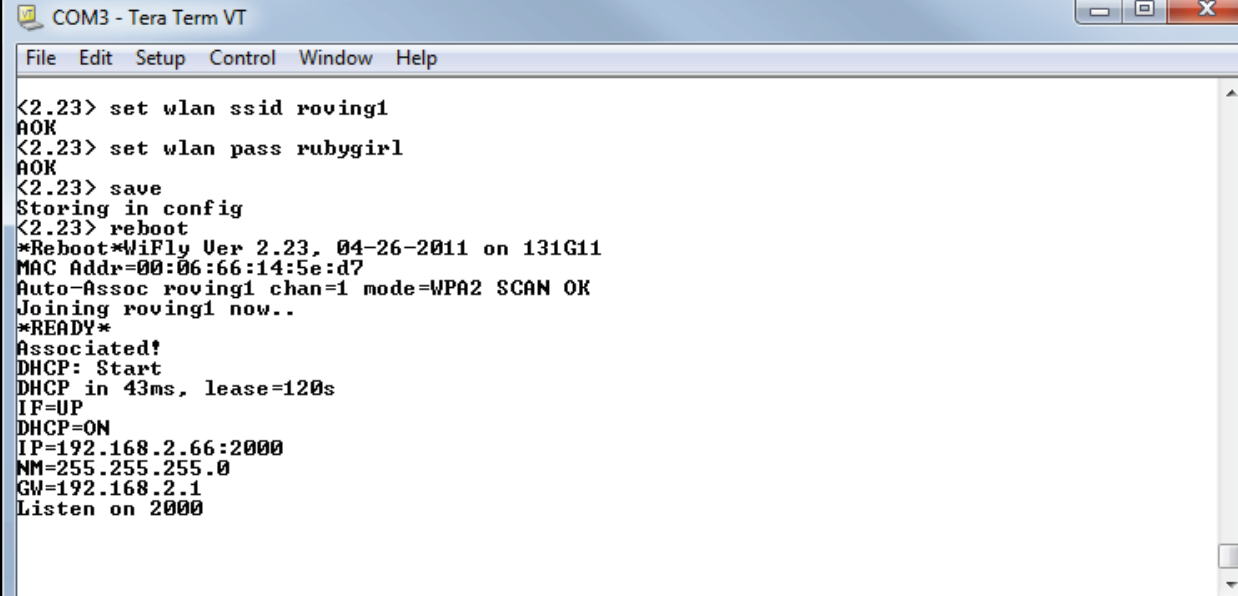

```
COM3 - Tera Term VT
File Edit Setup Control Window Help
<2.23> set wlan ssid roving1
AOK
<2.23> set wlan pass rubygirl
AOK
<2.23> save
Storing in config
<2.23> reboot
*Reboot*WiFly Ver 2.23, 04-26-2011 on 131G11
MAC Addr=00:06:66:14:5e:d7
Auto-Assoc roving1 chan=1 mode=WPA2 SCAN OK
Joining roving1 now..
*READY*
Associated!
DHCP: Start
DHCP in 43ms, lease=120s
IF=UP
DHCP=ON
IP=192.168.2.66:2000
NM=255.255.255.0
GW=192.168.2.1
Listen on 2000
```

## 2.4.4 Configuration Using AP Mode

AP mode released as part of the standard firmware replaces Ad hoc mode.

AP mode provides several advantages over Ad hoc mode.

In AP mode:

- The module creates a soft AP network to which Android devices (smartphones and tablets) can join. (Android devices do not support ad hoc networking.)
- The module runs a DHCP server and issues IP addresses to seven clients, which is much faster than automatic IP in Ad hoc mode.
- The RN131/171 module supports security, unlike Ad hoc, which is an open mode.
- The module supports routing between clients.

Load the appropriate firmware, version 2.45 or later, to enable the AP mode. Modify the boot image to version 2.45 to use AP mode. Change the module's firmware image using the **boot image** <value> command. After changing the boot image, reset the module back to the factory defaults using the Factory reset and **reboot** commands.

The following firmware images are available from the Microchip website:

- **Wifly\_EZX-236.img**—Ad hoc mode firmware for RN171
- **Wifly\_GSX-236.img**—Ad hoc mode firmware for RN131
- **Wifly\_EZX-245.img**—Soft AP mode for RN171
- **Wifly\_GSX-245.img**—Soft AP mode for RN131

**Note:** RN131/171 module firmware can be upgraded to the latest version through FTP update. For additional information on FTP update and commands, refer to "WiFly Command Reference, Advanced Features and Applications User's Guide" from the Microchip web site at <http://www.microchip.com>.

In firmware version 2.36 (ad hoc mode), the auto join feature is enabled to maintain backwards compatibility. In version 2.45 (AP mode), auto join is disabled and must be explicitly enabled using the **set wlan join 1** command.

The following sections describe how to use the AP mode with RN Wi-Fi modules, including configuring the module to act as an AP, enabling AP mode in hardware and software, and ending data to the module from a remote host.

## 2.4.5 Enabling AP mode

There are two methods for enabling AP mode, hardware and software, as described in the following sections.

### 2.4.5.1 ENABLE IN HARDWARE

To enable AP mode in hardware, hold GPIO9 high at 3.3V and then reboot (or power cycle) the module. The module boots up in AP mode with the DHCP server enabled.

**Note:** For more details on programming/configuring the module, refer to the documentation of module used on the Support page from the Microchip web site at <http://www.microchip.com>.

Table 2-2 shows the default AP mode settings.

**TABLE 2-2: DEFAULT AP MODE SETTINGS**

Setting	AP Mode Default
SSID	WiFlyAP-XX, where XX is the last two bytes of the module's MAC address
Channel	1
DHCP server	Enabled
IP address	1.2.3.4
Netmask	255.255.255.0
Gateway	1.2.3.4

When the module boots, other Wi-Fi-enabled devices (PCs, iPhones, iPads, Android tablets, etc.) must be able to see the module when they scan for access points.

**Note:** It is recommended to set the RN131/171 module as a gateway when creating point-to-point network between devices (Wi-Fi network only).

If devices such as smartphones and tablets (iPads, Android tablets, etc.) with a WAN connection associate to the soft AP network, Roving Networks recommends setting the gateway to 0. This setting enables these smartphones route the data from Wi-Fi to the 3G or 4G WAN network.

### 2.4.5.2 ENABLE IN SOFTWARE

Enable AP mode in software using the **set wlan join 7** command. Customize network settings such as the SSID, channel and IP address in software to create a custom AP mode. For example, the following commands create a custom AP mode in software:

```
set wlan join 7 // Enable AP mode
set wlan channel <value> // Specify the channel to create network
set wlan ssid <string> // Setup network SSID
set ip dhcp 4 // Enable DHCP server
set ip address <address> // Specify the IP address
set ip net <address> // Specify the subnet mask
set ip gateway <address> // Specify the gateway
save // Store settings
reboot // Reboot the module in AP mode
```

After rebooting, the module is in AP mode.

## 2.4.6 Using AP Mode

The following sections describe how to use AP mode, including connecting to the module, checking for the last device connected over TCP, viewing associated devices, enabling the link monitor and routing data between clients.

### 2.4.6.1 CONNECT TO THE MODULE

Once the module boots up in AP mode, any client device can associate with the network the module is broadcasting. Once associated, the module's DHCP server assigns an IP address to the client device.

The default lease time is 1 day i.e., 86,400 seconds. Based on the requirement, configure or change the lease time using the **set dhcp lease <value>** command, where <value> is the time in seconds. To view a list of devices associated with the module, use the **show lease** command. The command output is in the following format with commas delimiting the fields:

IP address assigned	Client MAC address	Remaining lease time (in seconds)	Host name
---------------------	--------------------	-----------------------------------	-----------

Figure 2-8 shows example output from the show lease command.

**FIGURE 2-8: SHOW LEASE COMMAND EXAMPLE OUTPUT**

```
<2.42> show lease
1.2.3.10,f0:cb:a1:2b:63:59,153,*
1.2.3.11,00:00:00:00:00:00,0,
1.2.3.12,00:00:00:00:00:00,0,
1.2.3.13,00:00:00:00:00:00,0,
1.2.3.14,00:00:00:00:00:00,0,
1.2.3.15,00:00:00:00:00:00,0,
1.2.3.16,00:00:00:00:00:00,0,
<2.42>
```

**Note:** In AP mode, the module can assign a DHCP lease to 7 clients. However, not all clients report the host name. In this case, the module reports the name as an asterisk (\*).

Once a client is associated to the network, it can open a TCP connection to the RN131/171 module. After successfully opening a TCP connection, the client receives a **\*HELLO\*** message. The RN131/171 module prints **\*OPEN\*** on the UART, indicating an open TCP connection.

## Chapter 3. Application Design Concerns

### 3.1 INTRODUCTION

This section provides the design concerns related to powering the evaluation board, sensor interface settings, Ad hoc mode and restoring factory settings.

#### 3.1.1 Powering the Module

The RN131/RN171 Evaluation Board is powered using the USB cable or through the battery pack, which holds two AAA batteries. However, RN131 Evaluation Board can also be powered using air-wiring.

**Note:** The RN171 module can also be powered through the USB cable while a battery pack is installed.

#### 3.1.2 Sensor Interfaces

The input voltage on the sensor inputs must not exceed 1.2V. The Analog-to-Digital Converter (ADC) saturates at 400 mV. It is recommended to use the sensor power output to drive any analog devices that are attached to the sensor pins.

**Note:** Sensor pins 2 and 3 have a resistor network in front of sensors 4 and 5, respectively. Hence, these pins can be driven with up to 3.3V DC.

#### 3.1.3 GPIO9 Functions

The AP push button is connected to GPIO9. Depending on the state of GPIO9, the module enters into three different modes: AP mode, Factory reset and WPS mode.

##### 3.1.3.1 AP MODE

To put the module into AP mode, GPIO9 must be high when the module powers up or wakes from a sleep state. Press the AP mode button to drive GPIO9 high, and then press the RESET button to reset the module. The module is in default AP mode, which creates a default access point network with the default parameters as listed in [Table 3-1](#).

**Note:** This default mode overwrites any software settings.

**TABLE 3-1: DEFAULT AP MODE SETTINGS**

Setting	AP Mode Default
SSID	WiFiAP-XX, where XX is the last two bytes of the module's MAC address
Channel	1
DHCP Server	Enabled
IP Address	1.2.3.4
Netmask	255.255.255.0
Gateway	1.2.3.4

Once the module boots, other Wi-Fi-enabled devices (such as, computers, iPhones, iPads, android tablets, etc.) are able to find the module when access points are scanned.

### 3.1.3.2 FACTORY RESET

In the Factory Reset mode, the module is restored to the factory defaults.

Perform the following steps to restore the defaults:

1. Put the module into default AP mode as described in **AP Mode**.
2. Press the **AP Mode** push button 5 times (with 1 or more seconds between presses).

This feature is useful in case the module is misconfigured and is no longer responding.

### 3.1.4 Reset

The RESET push button reboots the module.

---

---

## **Appendix A. RN131 and RN171 Evaluation Kits Schematic**

---

---

### **A.1 INTRODUCTION**

This appendix provides the RN131 and RN171 Evaluation Boards schematic, PCB layout and Bill of Materials (BOM).

- [RN131 and RN171 Evaluation Kits Schematic](#)
- [RN131 and RN171 Evaluation Kits PCB Layout and Assembly Drawings](#)
- [RN131 and RN171 Evaluation Kits Bill of Materials](#)
- [RN131 and RN171 Evaluation Kits Physical Dimensions](#)

### **A.2 RN131 AND RN171 EVALUATION KITS SCHEMATIC**

[Figure A-1](#) and [Figure A-2](#) show the Evaluation Boards schematic.

FIGURE A-1: RN131 EVALUATION BOARD SCHEMATIC

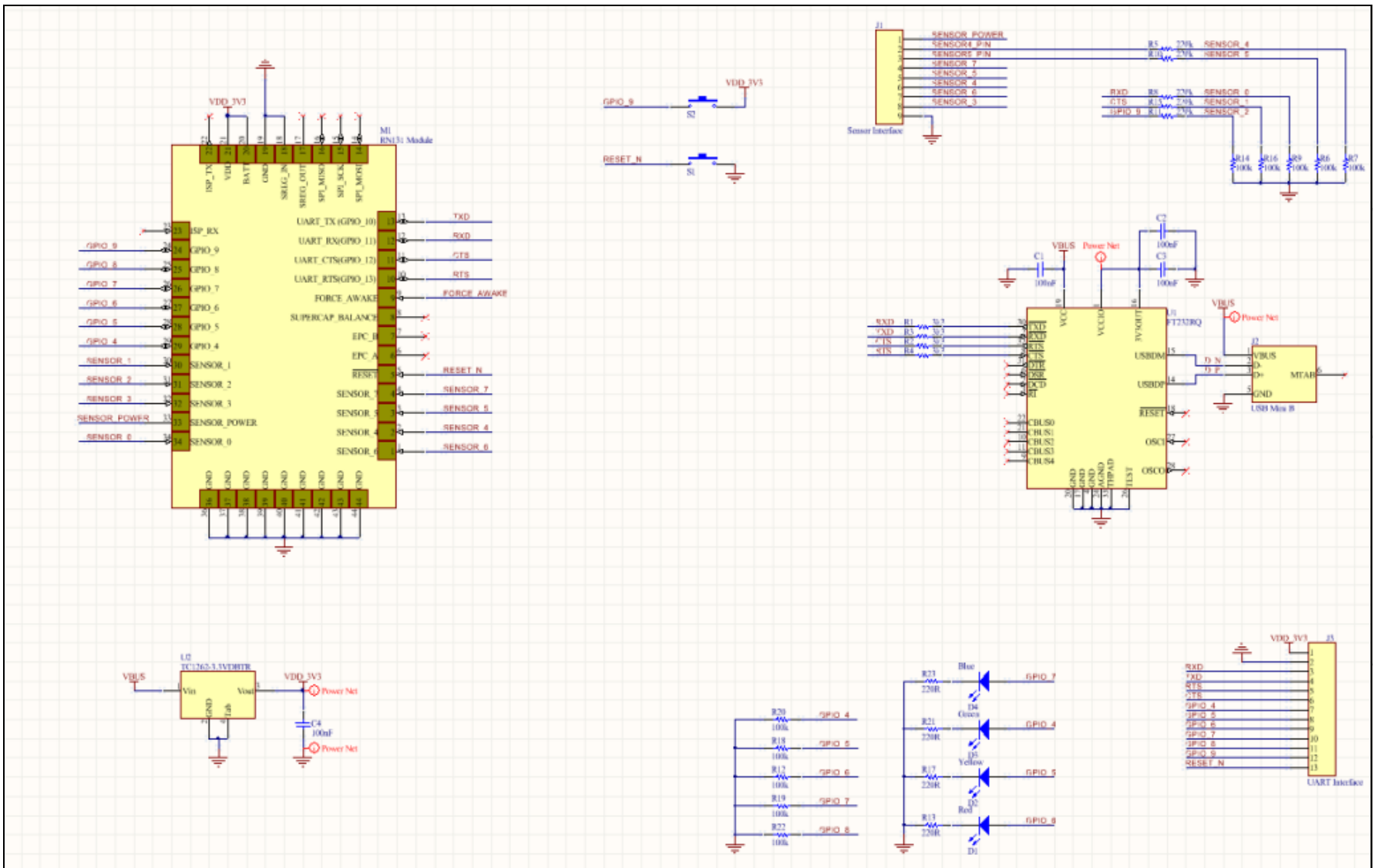
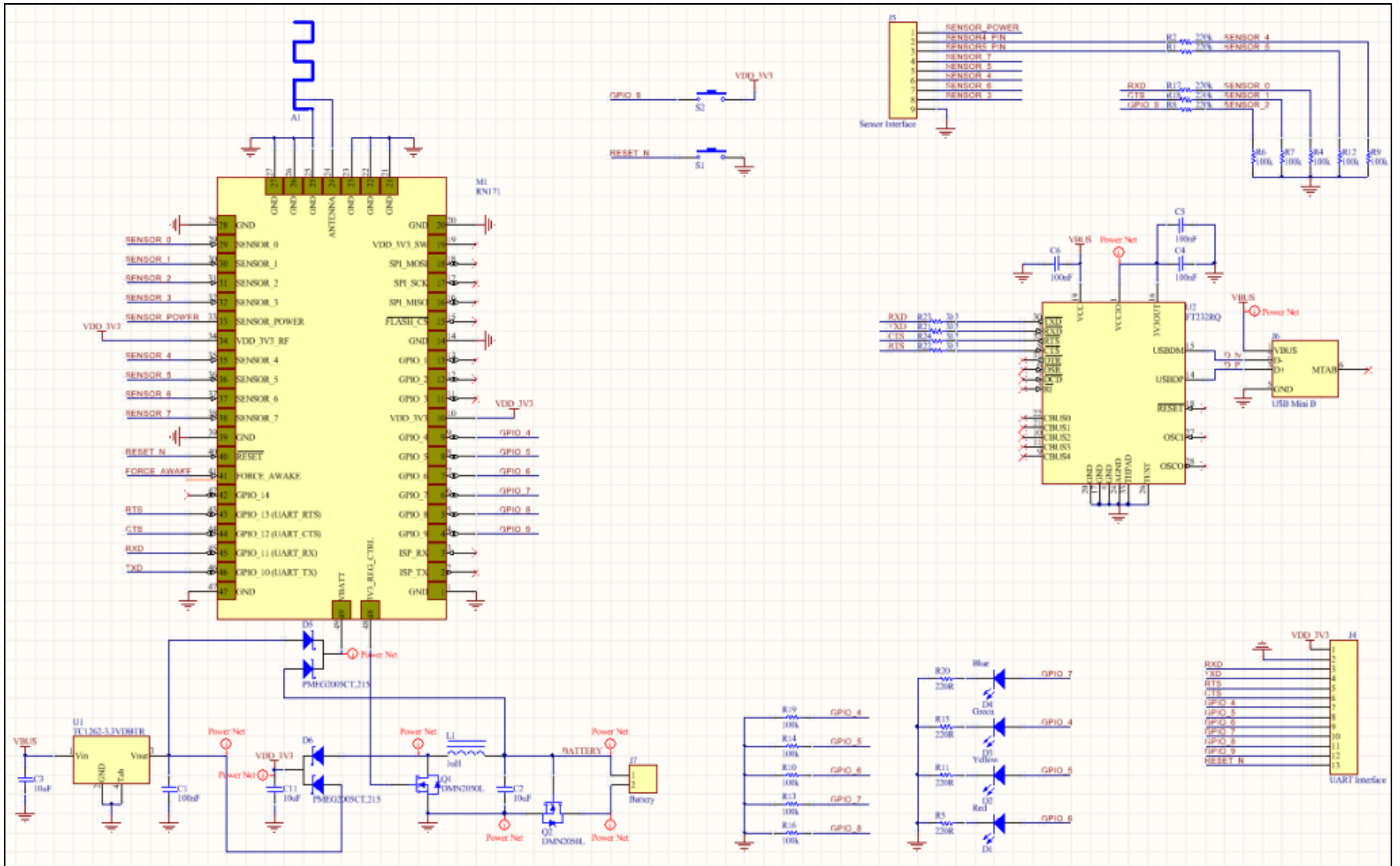



FIGURE A-2: RN171 EVALUATION BOARD SCHEMATIC



# RN131/171 Evaluation Kit User's Guide

## A.3 RN131 AND RN171 EVALUATION KITS PCB LAYOUT AND ASSEMBLY DRAWINGS

The RN131/171 Evaluation Board is a 2-layer, FR4, 0.062 inch, plated through a hole PCB construction. [Figure A-3](#) through [Figure A-14](#) show the PCB constructions and Assembly Drawings.

FIGURE A-3: RN131 EVALUATION BOARD TOP SILKSCREEN



FIGURE A-4: RN131 EVALUATION BOARD BOTTOM SILKSCREEN

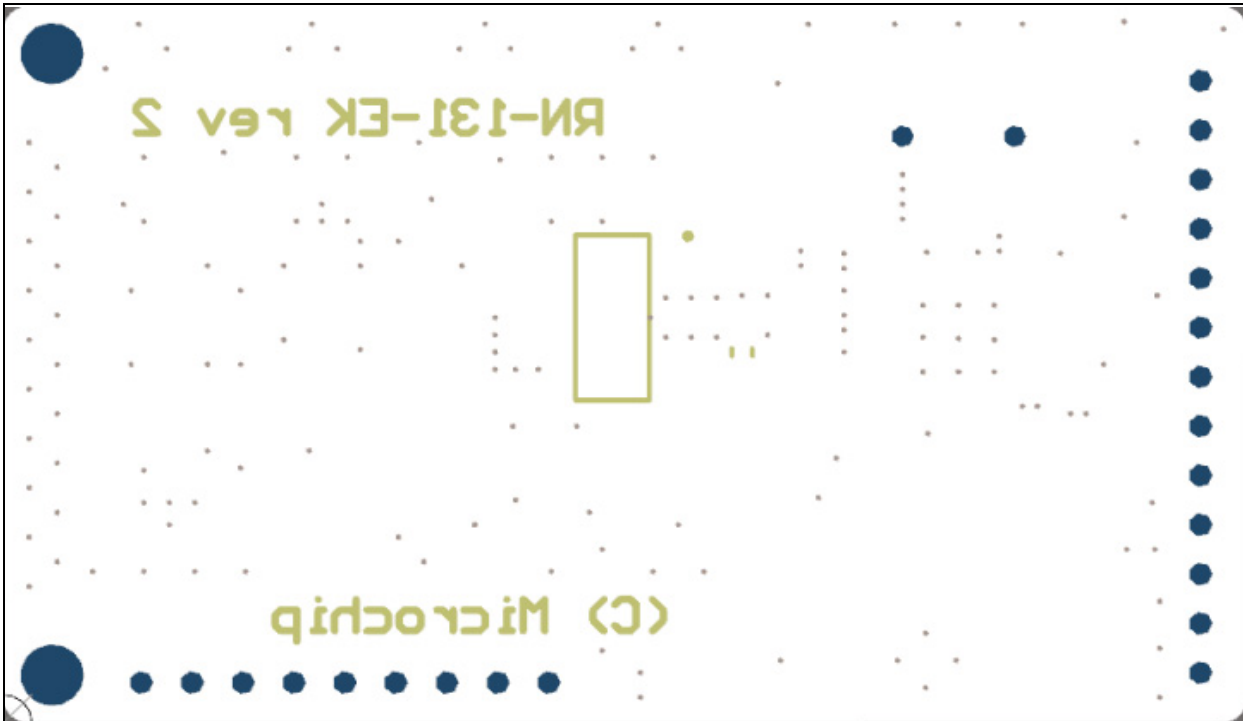

FIGURE A-5: RN131 EVALUATION BOARD TOP COPPER

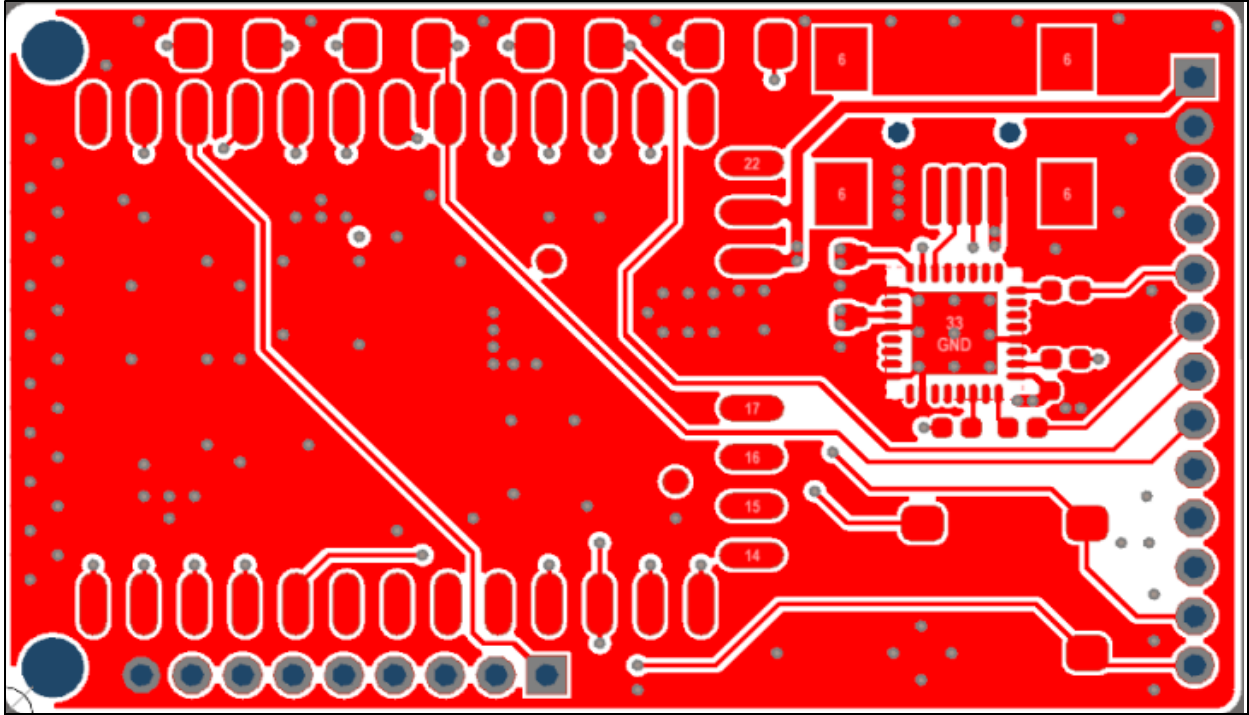
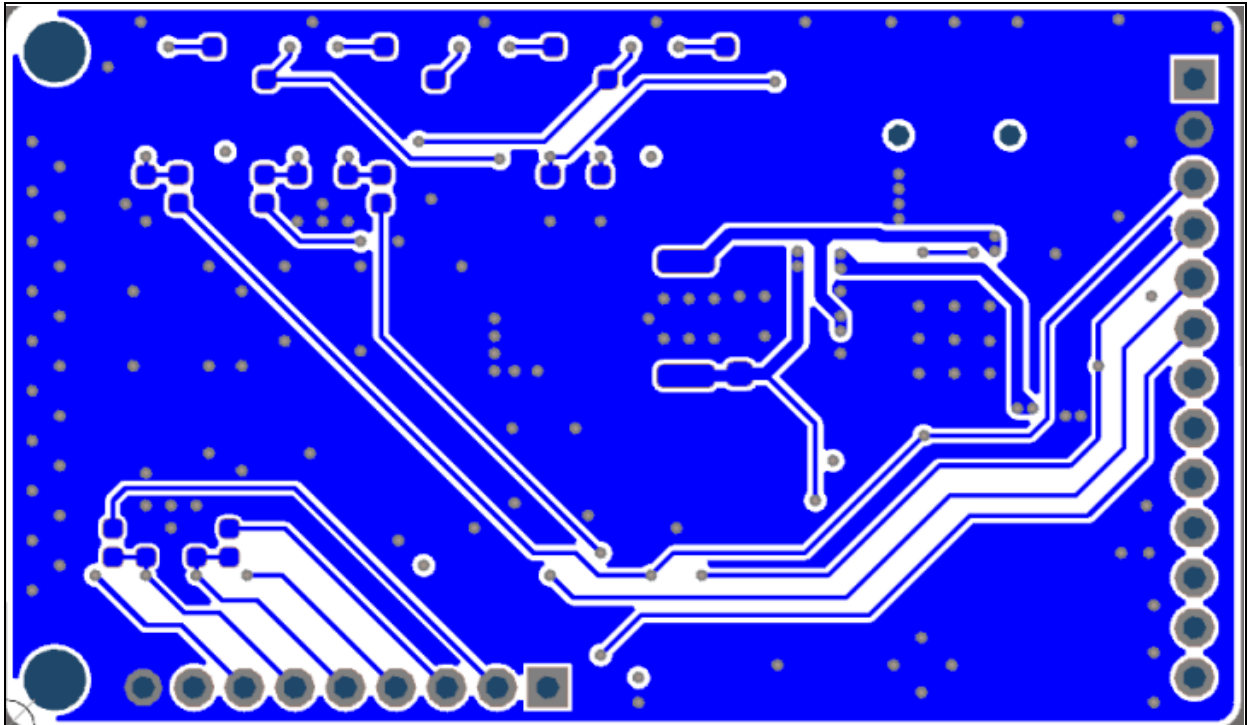

FIGURE A-6: RN131 EVALUATION BOARD BOTTOM COPPER



# RN131/171 Evaluation Kit User's Guide

FIGURE A-7: RN131 EVALUATION BOARD TOP ASSEMBLY

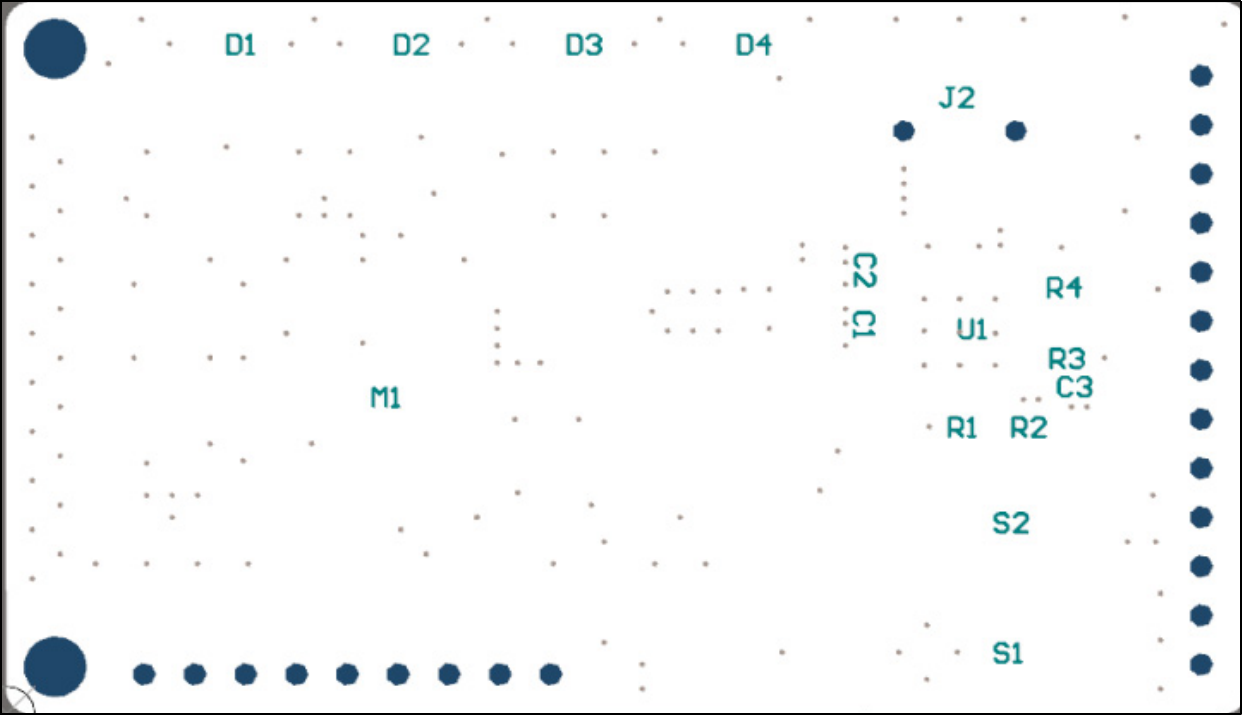

FIGURE A-8: RN131 EVALUATION BOARD BOTTOM ASSEMBLY

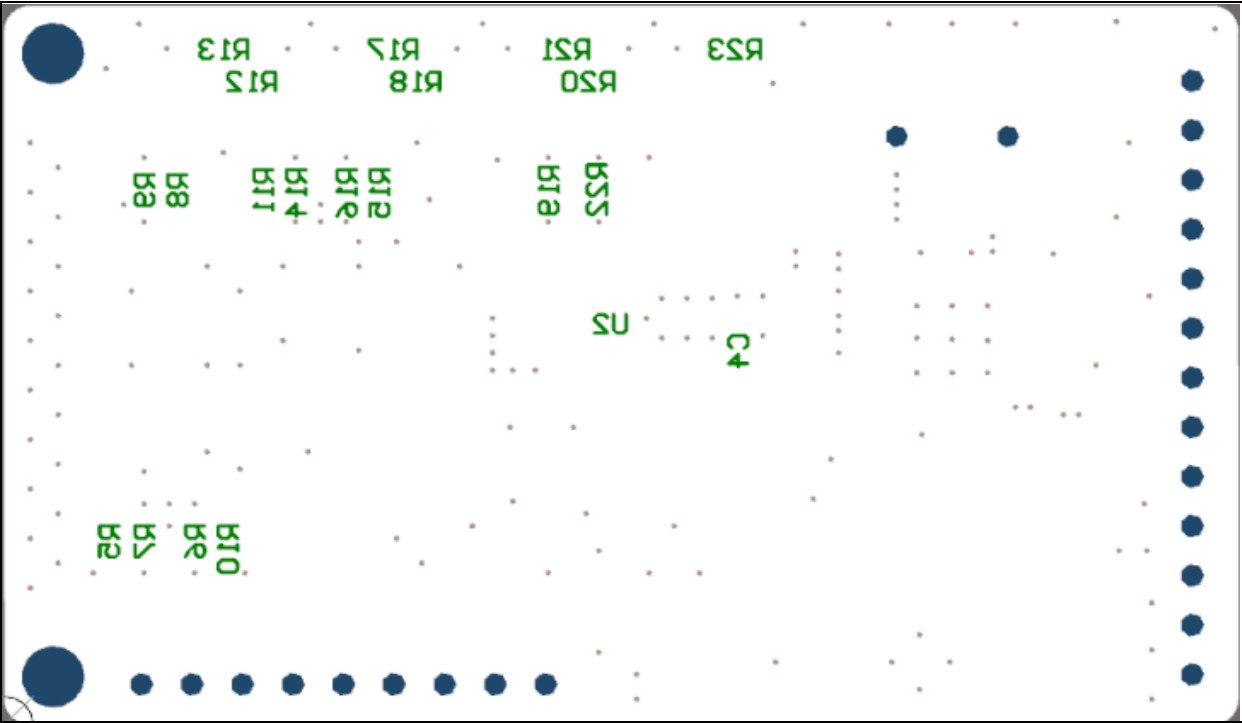

FIGURE A-9: RN171 EVALUATION BOARD TOP SILKSCREEN

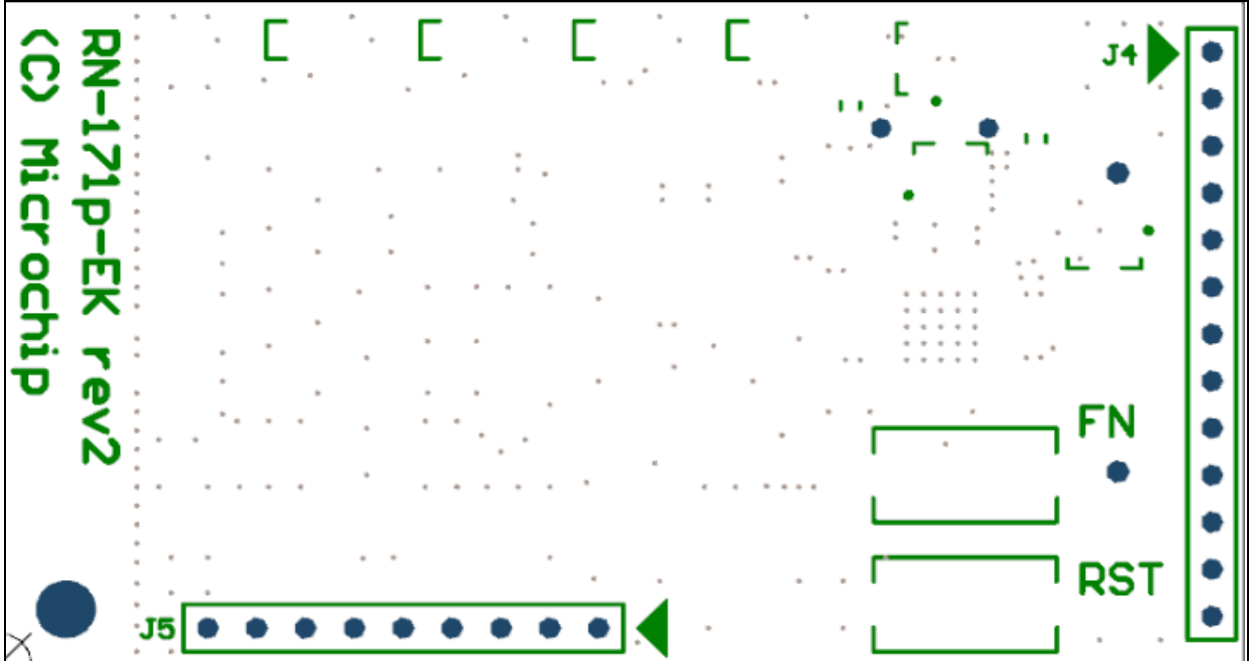
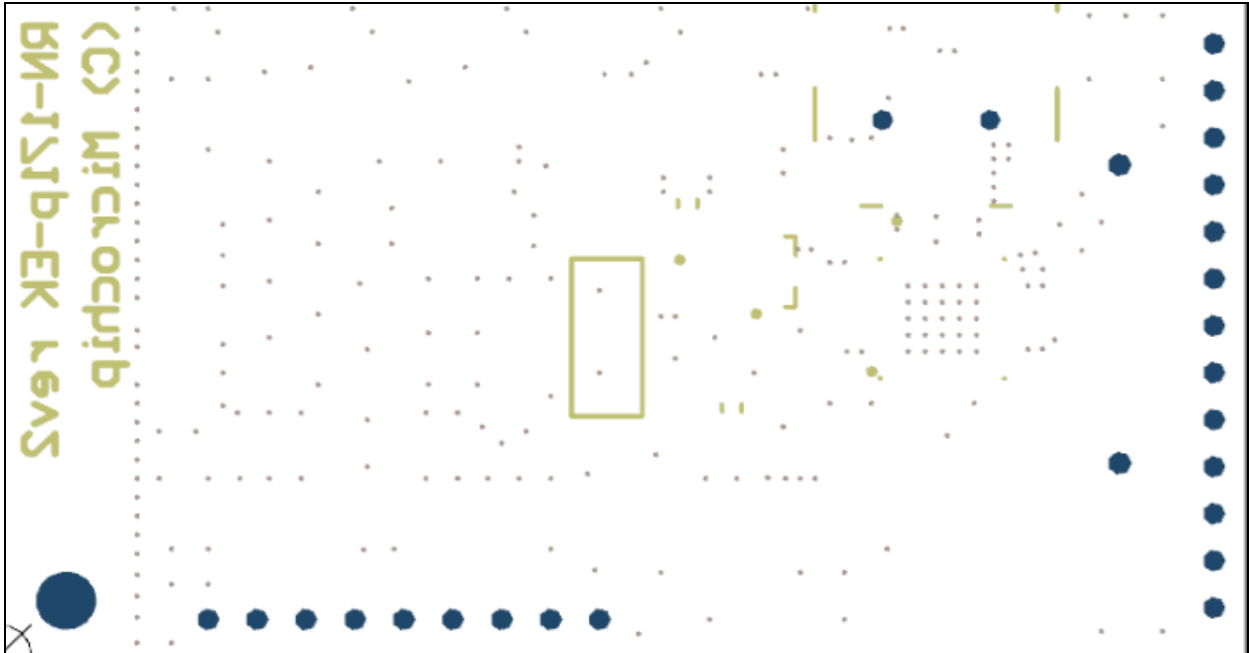
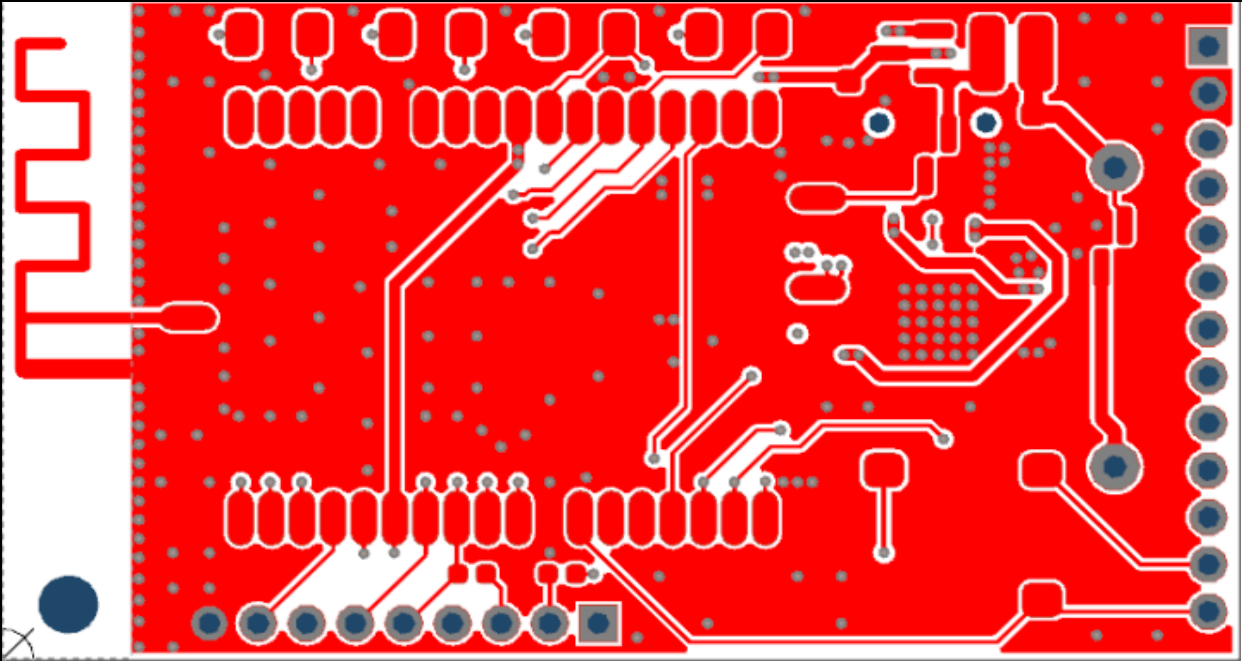

FIGURE A-10: RN171 EVALUATION BOARD BOTTOM SILKSCREEN



**FIGURE A-11: RN171 EVALUATION BOARD TOP COPPER**



**FIGURE A-12: RN171 EVALUATION BOARD BOTTOM COPPER**

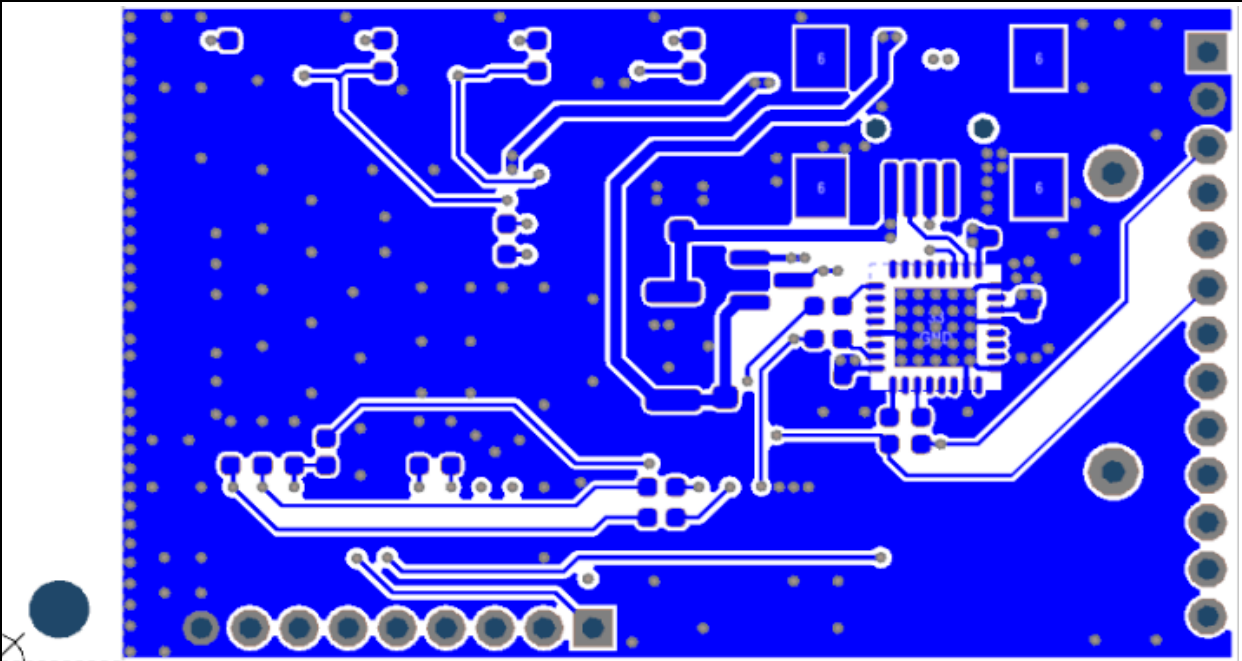

FIGURE A-13: RN171 EVALUATION BOARD TOP ASSEMBLY

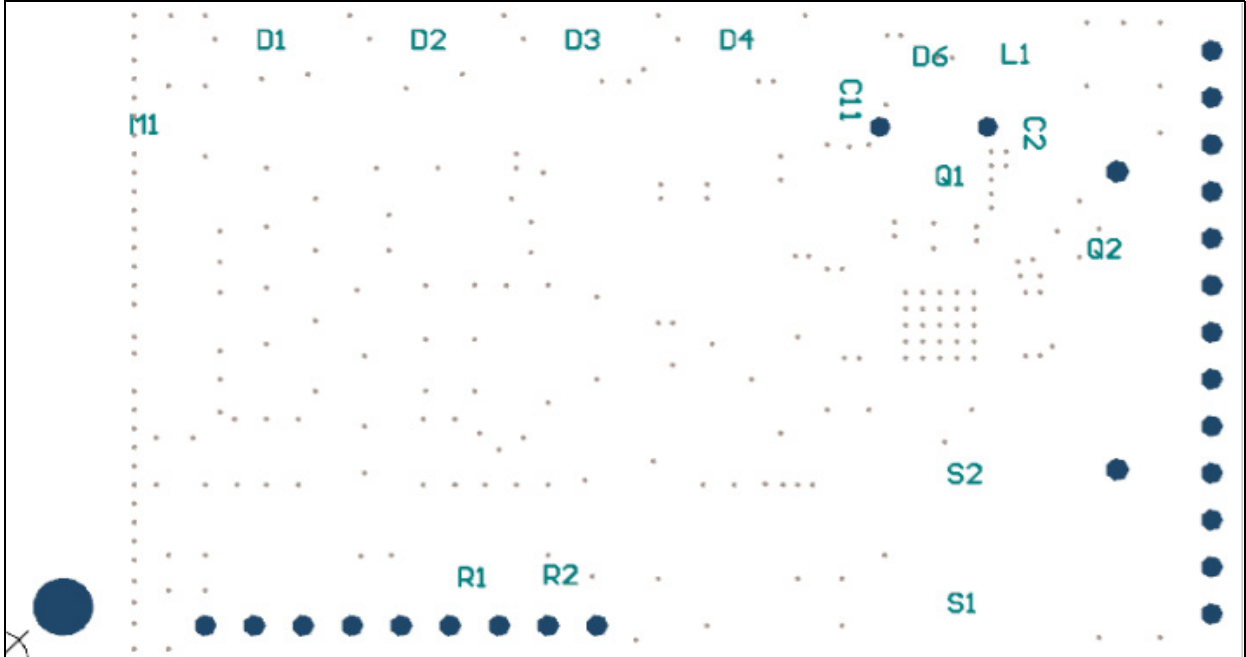
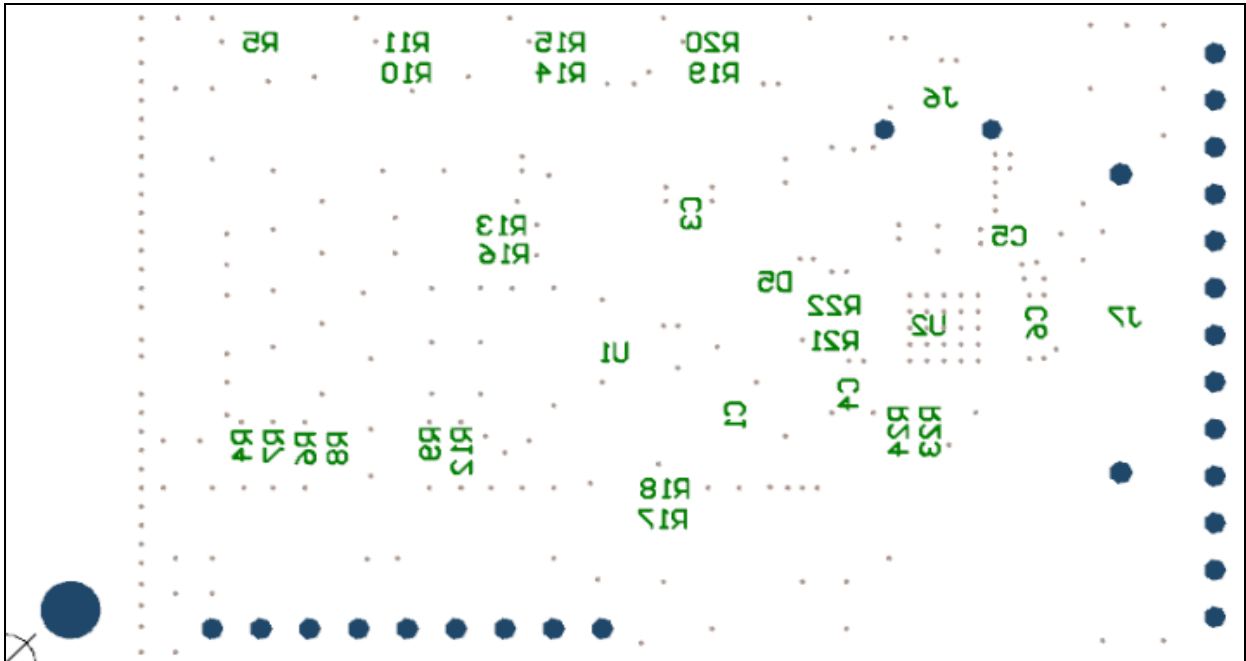

FIGURE A-14: RN171 EVALUATION BOARD BOTTOM ASSEMBLY



# RN131/171 Evaluation Kit User's Guide

## A.4 RN131 AND RN171 EVALUATION KITS BILL OF MATERIALS

TABLE A-1: RN131 EVALUATION BOARD BILL OF MATERIALS (BOM)

Reference	Value	Description	Vendor	Vendor P/N
C1, C2, C3	100 nF	Cap ceramic, -20%, 80%, 16V, Y5V, 0402	Yageo	CC0402ZRY5V7BB104
C4	100 nF	Cap ceramic, -20% / 80%, 16V, Y5V, 0603	Yageo	CC0603ZRY5V7BB104
D1	Red	Clear, Red LED, 10 mA, 1.8V, 638 nm, 130 degrees, 1206	Lite-On Inc	LTST-C150CKT
D2	Yellow	Clear, Yellow LED, 10 mA, 2.1V, 588 nm, 130 degrees, 1206	Lite-On Inc	LTST-C150YKT
D3	Green	Clear, Green LED, 10 mA, 2.1V, 569 nm, 130 degrees, 1206	Lite-On Inc	LTST-C150GKT
D4	Blue	Clear, Blue LED, 20 mA, 3.3V, 470 nm, 130 degrees, 1206	Lite-On Inc	LTST-C150TBKT
J2	USB Mini B	CONN USB RCPT MINI B 5PS R/A SMD	JAE	DX2R005HN2E700
M1	—	RN131 Module	Microchip	RN-131
R1, R2, R3, R4	3k3	Res, 5%, 0.1W, 0402	Panasonic - ECG	ERJ-2GEJ332X
R5, R8, R10, R11, R15	220k	Res, 5%, 0.1W, 0402	Panasonic - ECG	ERJ-2GEJ224X
R6, R7, R9, R12, R14, R16, R18, R19, R20, R22	100k	Res, 5%, 0.1W, 0402	Panasonic - ECG	ERJ-2GEJ104X
R13, R17, R21, R23	220R	Res, 5%, 0.1W, 0402	Panasonic - ECG	ERJ-2GEJ221X
S1, S2	Push button	SWITCH TACTILE SPST-NO 0.05A 32V	C&K Components	KSR211J
U1	FT232RQ	IC USB FS SERIAL UART 32-QFN	FTDI	FT232RQ-REEL
U2	TC1262-3.3V	Linear Voltage Regulator	Microchip	TC1262-3.3VDBTR



**TABLE A-2: RN171 EVALUATION BOARD BILL OF MATERIALS (BOM)**

Reference	Value	Description	Vendor	Vendor P/N
C1	100 nF	Cap ceramic, -20% / 80%, 16V, Y5V, 0603	Yageo	CC0603ZRY5V7BB104
C2, C3, C11	10 uF	Cap ceramic, 20%, 6.3V, X5R, 0603	TDK Corporation	C1608X5R0J106M
C4, C5, C6	100 nF	Cap ceramic, -20%, 80%, 16V, Y5V, 0402	Yageo	CC0402ZRY5V7BB104
D1	Red	Clear, Red LED, 10 mA, 1.8V, 638 nm, 130 degrees, 1206	Lite-On Inc	LTST-C150CKT
D2	Yellow	Clear, Yellow LED, 10 mA, 2.1V, 588 nm, 130 degrees, 1206	Lite-On Inc	LTST-C150YKT
D3	Green	Clear, Green LED, 10 mA, 2.1V, 569 nm, 130 degrees, 1206	Lite-On Inc	LTST-C150GKT
D4	Blue	Clear, Blue LED, 20 mA, 3.3V, 470 nm, 130 degrees, 1206	Lite-On Inc	LTST-C150TBKT
D5, D6	PMEG2005CT, 215	Dual Schottky diode, 1A, 20V, SOD-123F	NXP Semiconductor	PMEG2005CT,215
J6	USB Mini B	CONN USB RCPT MINI B 5PS R/A SMD	JAE	DX2R005HN2E700
L1	1uH	INDUCTOR 1.0UH 30% SMD	Taiyo Yuden	NR3015T1R0N
M1	—	RN171 Module	Microchip	RN-171
Q1, Q2	DMN2050L	N MOSFET 5.9A, 20V, 29 mOhm, SOT23-3	Diodec Inc	DMN2050L-7
R1, R2, R8, R17, R18	220k	Res, 5%, 0.1W, 0402	Panasonic - ECG	ERJ-2GEJ224X
R4, R6, R7, R9, R10, R12, R13, R14, R16, R19	100k	Res, 5%, 0.1W, 0402	Panasonic - ECG	ERJ-2GEJ104X
R5, R11, R15, R20	220R	Res, 5%, 0.1W, 0402	Panasonic - ECG	ERJ-2GEJ221X
R21, R22, R23, R24	3k3	Res, 5%, 0.1W, 0402	Panasonic - ECG	ERJ-2GEJ332X
S1, S2	Push button	SWITCH TACTILE SPST-NO 0.05A 32V	C&K Components	KSR211J
U1	TC1262-3.3V	Linear Voltage Regulator	Microchip	TC1262-3.3VDBTR
U2	FT232RQ	IC USB FS SERIAL UART 32-QFN	FTDI	FT232RQ-REEL

# RN131/171 Evaluation Kit User's Guide

---

## A.5 RN131 AND RN171 EVALUATION KITS PHYSICAL DIMENSIONS

Figure A-15 and Figure A-16 show the physical dimensions of the RN131 and RN171 Evaluation Boards.

**FIGURE A-15: RN131 EVALUATION BOARD PHYSICAL DIMENSIONS**

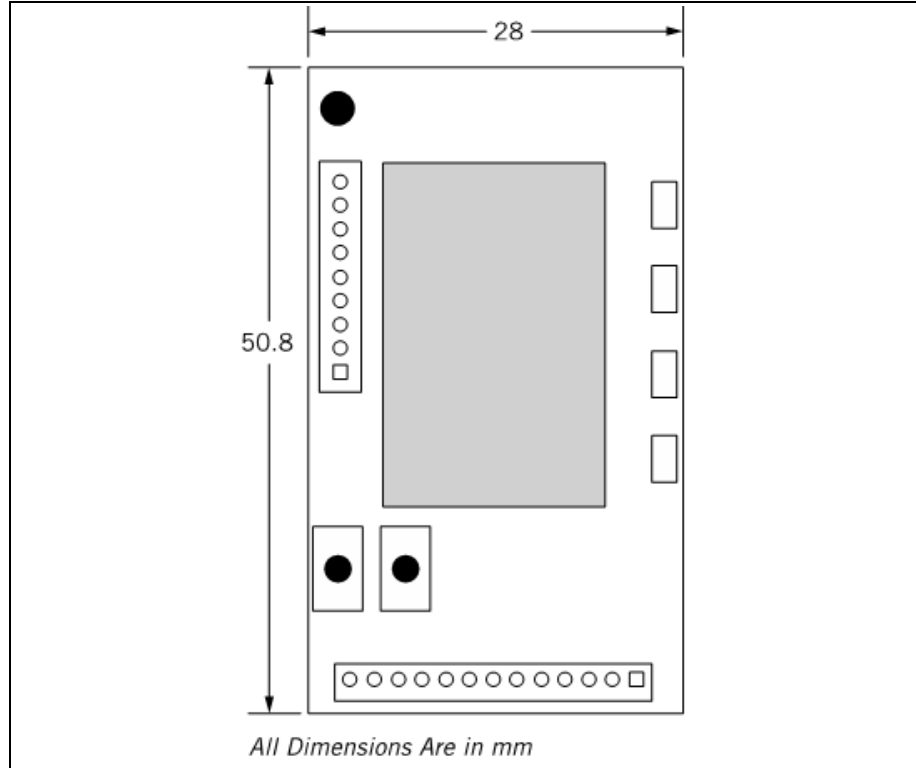

**FIGURE A-16: RN171 EVALUATION BOARD PHYSICAL DIMENSIONS**

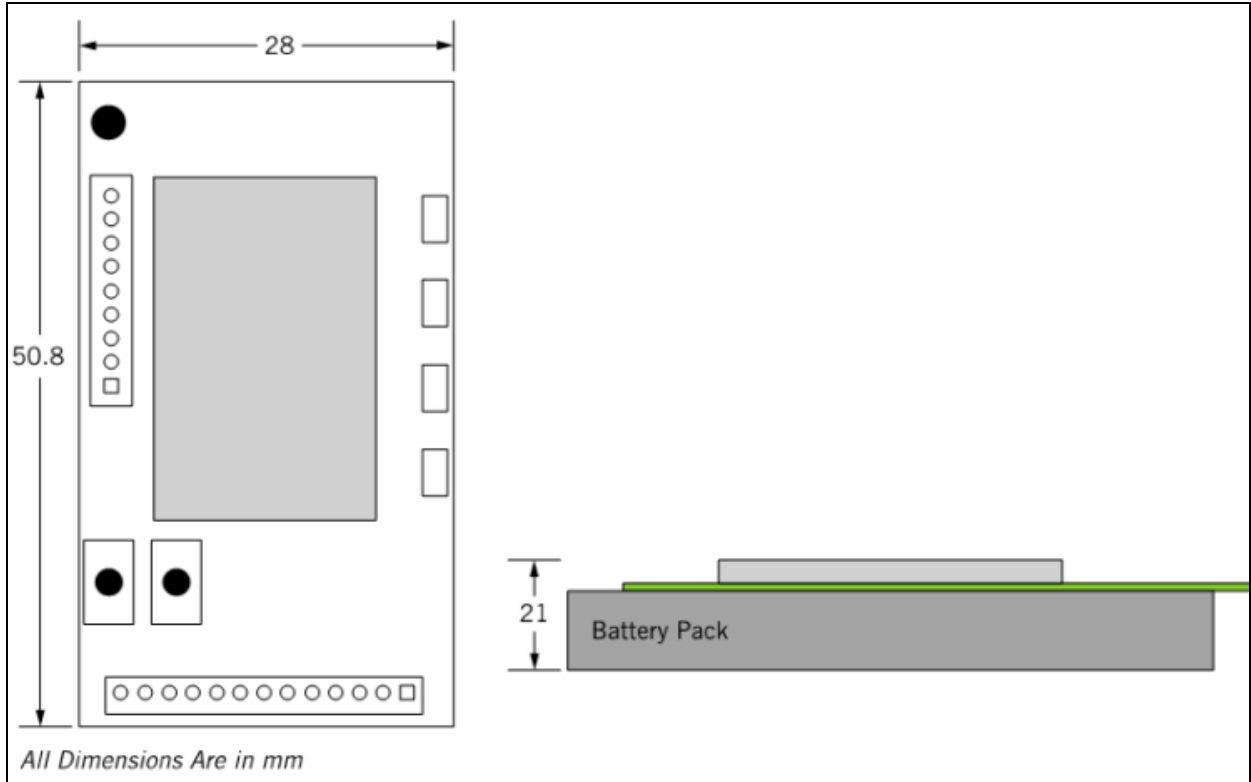

NOTES:

---



---

## Index

---



---

<b>A</b>		<b>S</b>	
Ad hoc parameters.....	24	SMA Connectors.....	18
Analog-to-Digital Converter (ADC).....	29	SoftAP mode.....	13
ASCII commands.....	13	<b>T</b>	
Assembly Drawings.....	34	TCP/IP networking.....	13
<b>B</b>		Telnet.....	13
Bill of Materials (BOM).....	8, 31	Terminal Emulator Application.....	20
<b>C</b>		<b>U</b>	
COM Port.....	18	U.FL. connector.....	13
Command mode.....	21	UART (RS232).....	7
Customer Notification Service.....	10	USB cable.....	13
Customer Support.....	10	USB Connector.....	18
<b>D</b>		USB interface.....	7
Data mode.....	21	USB-to-serial cable.....	22
Demonstration Application.....	19, 29	<b>W</b>	
Documentation		Warranty Registration.....	9
Conventions.....	8	Wi-Fi Alliance.....	13
Layout.....	7	WPA2-PSK.....	13
<b>E</b>		WPS mode.....	29
Explorer 16 Development Board.....	9	WWW Address.....	10
<b>F</b>			
FTDI drivers.....	19		
FTP client.....	13		
FTP host address.....	24		
<b>I</b>			
IEEE 802.11 b/g transceiver.....	13		
Internet Address.....	10		
<b>L</b>			
LEDs.....	18		
<b>M</b>			
Microchip Internet Web Site.....	10		
MRF24XA.....	7		
<b>P</b>			
PCB constructions.....	34		
PCB layers.....	34		
PCB layout.....	8, 31		
Physical Dimensions.....	42		
PICDEM™ PIC18 Explorer.....	9		
<b>R</b>			
Real-time clock.....	13		
Recommended Reading.....	9		
Red LED.....	25		
RN131/171 Evaluation Board.....	7		
RoHS compliant.....	13		



# MICROCHIP

## Worldwide Sales and Service

### AMERICAS

**Corporate Office**  
2355 West Chandler Blvd.  
Chandler, AZ 85224-6199  
Tel: 480-792-7200  
Fax: 480-792-7277  
Technical Support:  
<http://www.microchip.com/support>  
Web Address:  
[www.microchip.com](http://www.microchip.com)

**Atlanta**  
Duluth, GA  
Tel: 678-957-9614  
Fax: 678-957-1455

**Boston**  
Westborough, MA  
Tel: 774-760-0087  
Fax: 774-760-0088

**Chicago**  
Itasca, IL  
Tel: 630-285-0071  
Fax: 630-285-0075

**Cleveland**  
Independence, OH  
Tel: 216-447-0464  
Fax: 216-447-0643

**Dallas**  
Addison, TX  
Tel: 972-818-7423  
Fax: 972-818-2924

**Detroit**  
Farmington Hills, MI  
Tel: 248-538-2250  
Fax: 248-538-2260

**Indianapolis**  
Noblesville, IN  
Tel: 317-773-8323  
Fax: 317-773-5453

**Los Angeles**  
Mission Viejo, CA  
Tel: 949-462-9523  
Fax: 949-462-9608

**Santa Clara**  
Santa Clara, CA  
Tel: 408-961-6444  
Fax: 408-961-6445

**Toronto**  
Mississauga, Ontario,  
Canada  
Tel: 905-673-0699  
Fax: 905-673-6509

### ASIA/PACIFIC

**Asia Pacific Office**  
Suites 3707-14, 37th Floor  
Tower 6, The Gateway  
Harbour City, Kowloon  
Hong Kong  
Tel: 852-2401-1200  
Fax: 852-2401-3431

**Australia - Sydney**  
Tel: 61-2-9868-6733  
Fax: 61-2-9868-6755

**China - Beijing**  
Tel: 86-10-8569-7000  
Fax: 86-10-8528-2104

**China - Chengdu**  
Tel: 86-28-8665-5511  
Fax: 86-28-8665-7889

**China - Chongqing**  
Tel: 86-23-8980-9588  
Fax: 86-23-8980-9500

**China - Hangzhou**  
Tel: 86-571-2819-3187  
Fax: 86-571-2819-3189

**China - Hong Kong SAR**  
Tel: 852-2943-5100  
Fax: 852-2401-3431

**China - Nanjing**  
Tel: 86-25-8473-2460  
Fax: 86-25-8473-2470

**China - Qingdao**  
Tel: 86-532-8502-7355  
Fax: 86-532-8502-7205

**China - Shanghai**  
Tel: 86-21-5407-5533  
Fax: 86-21-5407-5066

**China - Shenyang**  
Tel: 86-24-2334-2829  
Fax: 86-24-2334-2393

**China - Shenzhen**  
Tel: 86-755-8864-2200  
Fax: 86-755-8203-1760

**China - Wuhan**  
Tel: 86-27-5980-5300  
Fax: 86-27-5980-5118

**China - Xian**  
Tel: 86-29-8833-7252  
Fax: 86-29-8833-7256

**China - Xiamen**  
Tel: 86-592-2388138  
Fax: 86-592-2388130

**China - Zhuhai**  
Tel: 86-756-3210040  
Fax: 86-756-3210049

### ASIA/PACIFIC

**India - Bangalore**  
Tel: 91-80-3090-4444  
Fax: 91-80-3090-4123

**India - New Delhi**  
Tel: 91-11-4160-8631  
Fax: 91-11-4160-8632

**India - Pune**  
Tel: 91-20-2566-1512  
Fax: 91-20-2566-1513

**Japan - Osaka**  
Tel: 81-6-6152-7160  
Fax: 81-6-6152-9310

**Japan - Tokyo**  
Tel: 81-3-6880-3770  
Fax: 81-3-6880-3771

**Korea - Daegu**  
Tel: 82-53-744-4301  
Fax: 82-53-744-4302

**Korea - Seoul**  
Tel: 82-2-554-7200  
Fax: 82-2-558-5932 or  
82-2-558-5934

**Malaysia - Kuala Lumpur**  
Tel: 60-3-6201-9857  
Fax: 60-3-6201-9859

**Malaysia - Penang**  
Tel: 60-4-227-8870  
Fax: 60-4-227-4068

**Philippines - Manila**  
Tel: 63-2-634-9065  
Fax: 63-2-634-9069

**Singapore**  
Tel: 65-6334-8870  
Fax: 65-6334-8850

**Taiwan - Hsin Chu**  
Tel: 886-3-5778-366  
Fax: 886-3-5770-955

**Taiwan - Kaohsiung**  
Tel: 886-7-213-7828  
Fax: 886-7-330-9305

**Taiwan - Taipei**  
Tel: 886-2-2508-8600  
Fax: 886-2-2508-0102

**Thailand - Bangkok**  
Tel: 66-2-694-1351  
Fax: 66-2-694-1350

### EUROPE

**Austria - Wels**  
Tel: 43-7242-2244-39  
Fax: 43-7242-2244-393

**Denmark - Copenhagen**  
Tel: 45-4450-2828  
Fax: 45-4485-2829

**France - Paris**  
Tel: 33-1-69-53-63-20  
Fax: 33-1-69-30-90-79

**Germany - Munich**  
Tel: 49-89-627-144-0  
Fax: 49-89-627-144-44

**Italy - Milan**  
Tel: 39-0331-742611  
Fax: 39-0331-466781

**Netherlands - Drunen**  
Tel: 31-416-690399  
Fax: 31-416-690340

**Spain - Madrid**  
Tel: 34-91-708-08-90  
Fax: 34-91-708-08-91

**UK - Wokingham**  
Tel: 44-118-921-5869  
Fax: 44-118-921-5820

11/29/12